MATERIALS FOR CRYOGENIC SERVICE: ENGINEERING PROPERTIES OF AUSTENITIC STAINLESS STEELS

Publication N° 4368

NiDI Distributed by the
Nickel Development Institute,
courtesy of Inco Limited

Materials for cryogenic service

Engineering properties of austenitic stainless steels

Contents list

Austenitic stainless steels normally
used for cryogenic applications

National specifications and pressure
vessel design codes

Tensile properties

Compressive properties

Impact test data

Effect of sensitization heat
treatment on impact strength

Fracture toughness

Fatigue strength

Welding

Properties of welded joints

Physical properties

INCO is a trademark

The information and data in this
publication are as complete and accurate
as possible at the time of publication.
The characteristics of a material can vary
according to the precise method of
production, fabrication and treatment.
Wherever available full details of the
condition of the test pieces are included.
As these data are derived from various
sources, suppliers of materials should
always be consulted concerning the
specific characteristics of their products.

First published 1974

© Copyright 1974

International Nickel Limited

Inco, the leading producer and marketer of nickel, conducts research and development programmes on nickel alloys, products and processes, establishing engineering and performance data. This knowledge is collated in a library of INCO databooks, which are freely available.

A companion title to this publication is:

4262 Materials for cryogenic service - 3½, 5 & 9% nickel steels & 36% nickel-iron alloy: engineering properties.

Conversion factors for stress units

Because of the variety of metric and non-metric units employed for stress values, and the possibility of further changes, conversion factors are given below for the more important of these, to and from SI metric units.

Note that the meganewton per square metre (MN/m²), newton per square millimetre (N/mm²) and megapascal (MPa) are arithmetically identical.

1 kgf/mm ²	=	9.807 MN/m ² , N/mm ² or MPa
		0.9807 daN/mm ²
10 ³ lbf/in ²	=	8.895 MN/m ² , N/mm ² or MPa
		0.8895 daN/mm ²
1 tonf/in ²	=	15.44 MN/m ² , N/mm ² or MPa
		1.544 daN/mm ²
1 MN/m ²	=	0.1 hbar or daN/mm ²
N/mm ²	=	0.145 10 ³ lbf/in ²
or MPa	=	0.0647 tonf/in ²
		0.102 kgf/mm ²
1 hbar	=	10 MN/m ² , N/mm ² or MPa
		1 daN/mm ²

The austenitic stainless steels used for cryogenic service

Out of the wide range of standard wrought austenitic stainless steels several have been used extensively for equipment operating at sub-zero temperatures which may be as low as the boiling point of liquid helium (-269°C). As the temperature is lowered the strength of these steels increases rapidly, whilst ductility and impact toughness are maintained at a high level as temperatures approach absolute zero. The steels are well suited for equipment handling liquid gases and for other liquids where corrosion resistance is also required, e.g., the low-temperature processing of foods and other products where product contamination must be held to a minimum.

The most widely used wrought stainless steels for cryogenic service are the AISI Types 304 and 304L, while Types 316, 316L, 321 and 347 are also used, dependent upon the availability in the particular form or size required. For temperatures below about -200°C the non-stabilized grades are generally preferred. Data for each of these types are included in the present publication together with summaries of the relevant European national specifications and steel designations. Data for the corresponding casting grades are also given.

Particular care should be exercised in selecting appropriate grades of cast stainless steel for cryogenic service since micro-segregation can cause local variations in composition and micro-

structure which exert important effects on properties. In both wrought and cast steels sufficient nickel should always be present to ensure adequate stability of the austenitic matrix at low temperatures. Furthermore, in cast grades containing carbide stabilizing additions it is generally desirable to avoid excessive amounts of inter-dendritic carbides.

Wrought stainless steels with controlled additions of nitrogen (possessing improved proof stress values and tensile strength in comparison with the traditional grades) are also used for service at cryogenic temperatures. These steels can be used at higher design stresses in pressure vessels and containers wherever their use is recognized in existing codes of practice and by the insurance companies and inspecting authorities. Some guidance on design-code approval by authoritative bodies is given in this publication, but the reader should ascertain the most up-to-date position from the authorities concerned in relation to the construction and use of particular equipment.

Specifications

The austenitic stainless steels suitable for cryogenic use are covered by several British Standard Specifications. The earliest of these is BS 1501-1506: 1958 'Steels for use in the chemical, petrochemical and allied industries' used in conjunction with British Standard 1510: 1958 'Low temperature supplementary

requirements to BS 1501-1506'. This specification series is applicable to bars and sections (at the time that this publication was prepared), but it has been replaced by more recent specifications for other product forms in particular by BS 1501: Part 3: 1973 for plate material. The requirements of the various British Standards together with those of other national specifications are summarized in Tables 1-6 (wrought) and 7-11 (cast). These tables show the AISI steel types with compositions nearest to those of the steels specified in European standards. However, a steel conforming to a given European national standard may not be entirely within the composition range of the AISI steel type shown or vice versa. Similarly, a steel conforming to a national specification of one European country may not be an exact equivalent of a similar type of steel complying with the specifications of other European countries. For contract purposes it is essential that the participants should consult the most recent specifications and agree on possible substitutions where this may be necessary.

Data for nitrogen-strengthened stainless steels produced in several European countries are given in Tables 12-17.

The design of pressure vessels for low-temperature service is covered by the specifications and codes listed in Tables 18 and 19 in which the allowable design stresses and/or operating temperature limits are summarized.

Mechanical properties at sub-zero temperatures

Tensile

The tensile strengths of chromium-nickel austenitic stainless steels increase markedly with decreasing temperature; yield strengths also increase but to a lesser degree. Correspondingly, there is some reduction in ductility as measured by elongation and reduction of area but ductility values remain high down to the lowest temperature for which data are available.

Typical tensile properties of annealed and cold-worked materials at sub-zero temperatures are shown in Figures 1-8, whilst Figure 9 gives low-temperature tensile data for cast Type CF-8 stainless steel.

Exposure to sub-zero temperatures has no adverse effect on the tensile properties when the alloys are subsequently tested at normal temperatures; see Table 20.

The modulus of elasticity in tension increases slightly with falling temperature; see Table 21.

Compression

Compressive strengths increase, like tensile strengths, with decrease in temperature. Compressive yield strengths and elastic limits of Type 304 steel are shown in Figure 10.

Impact properties and fracture toughness

The chromium-nickel stainless steels have good notch toughness down to at least -196°C . This is exemplified by the fact that some specifications and codes of practice do not specify a sub-zero impact test on wrought material to be used down to that temperature.

Typical impact properties are presented in Figures 11-17. These properties are little affected by prolonged exposure at -196°C as shown by the data in Table 22 for Type 304 steel.

Carbide precipitation can reduce the impact strength of Type 304 steel to a moderate extent at very low temperatures, but Types 304L, 316L and low-carbon Type 347 are little affected; see Figures 18 and 19.

A further indication of the notch insensitivity of the cryogenic stainless steels is provided by notched tensile

tests at low temperatures. For example, no significant decrease is observed in the notched to un-notched tensile strength ratio of Type 304L steel down to -250°C ; see Figure 20.

Few data are available on the low-temperature fracture toughness of austenitic stainless steels as determined by fracture mechanics test procedures. In other alloys having appreciably lower toughness, rapid fracture can occur with little energy absorption if defects are present from which a crack can grow to critical size as a result of cyclic application of stresses. However, in the case of austenitic stainless steels rapid propagation of a crack is resisted by plastic deformation ahead of it. In these circumstances a measure of the fracture toughness is obtainable from Crack Opening Displacement (COD) tests on notched bend test-pieces having a fatigue crack at the root of the notch or

a finely ground root. An example of the Load-Crack Opening Displacement curves obtained at low temperatures on Type 304N (nitrogen strengthened) steel is shown in Figure 21; these curves typify the high fracture toughness characteristics of the austenitic stainless steels in general.

Fatigue properties

Only limited data are available on the fatigue properties of chromium-nickel stainless steels at low temperatures. However, there is evidence that the endurance limit increases as the temperature decreases, as shown by the S-N curves in Figures 23-28. Both un-notched and notched bars show increasing fatigue strength with falling temperatures, although the improvement with notched bars tends to be less than with un-notched bars.

Welding

The wrought and cast stainless steels are readily weldable by any of the major electric fusion welding processes. Filler wires and electrodes used are of types designed by manufacturers to deposit weld metal having an analysis approximating that of the base metal and suitable for low-temperature service. (The austenitic stainless steel types 308 and 308L are used as fillers for welding Types 304 and 304L, respectively, while Type 347 is used as filler material for Type 321 steel.) Coated electrodes appropriate for manual arc welding the various grades of stainless steel are of the types given in Table 23.

Types 304 and 316 steels are generally suitable for welded cryogenic equipment in many corrosive environments, but in a limited number of corrosive media the heat-affected-zones may be subject to intergranular attack due to carbide precipitation caused by the welding thermal cycle. Whilst this can be overcome by post-weld re-annealing and rapidly cooling, it is not often practicable and in such cases the low-carbon steels, Types 304L and 316L, or the stabilized grades Types 321 and 347 should be used. However, in most cryogenic applications corrosion is not a problem and Type 304 steel is

generally satisfactory. Examples of applications where it is usually considered desirable to use the low-carbon (L) grades of stainless steel in preference to Type 304 are the deck cargo piping of LNG tankers and the membranes of certain membrane tank ship-board designs.

Stress-relief heat treatment of welded austenitic steel vessels is neither mandatory nor prohibited according to the code of practice laid down in the ASME Boiler and Pressure Vessel Code. Such heat treatment is not normally required for the majority of stainless steel cryogenic applications. However, where stress corrosion is anticipated, or to relieve stresses resulting from welding of heavy sections, it may be desirable to heat treat after welding if practicable. The procedure used involves heating to the temperatures recommended in Table 24 and holding for sufficient time to effect dissolution of precipitated carbides and to relieve internal stresses, followed by cooling at an appropriate rate to achieve a suitable balance between the need to minimize carbide re-precipitation and to avoid reintroduction of thermally-induced residual stress. Precipitation of carbides is most effectively minimized by cooling quick-

ly through the temperature range $930-430^{\circ}\text{C}$ (cooling between 930°C and 540°C should preferably be effected in less than three minutes), while slower cooling is desirable to keep internal stresses low. Slightly slower cooling rates may be used for the low-carbon and stabilized grades of steel with less risk of carbide precipitation than would be the case for the higher-carbon steels or the non-stabilized grades.

The high-proof strength stainless steels with controlled nitrogen additions are as readily weldable as the traditional standard grades, with the possible exception of autogenous welding of thin materials, and their corrosion-resistant properties are usually similar to the corresponding low-nitrogen grades. Special consumables are available although they are not normally essential to ensure sufficient strength in the weld deposit; those commonly used for the low-nitrogen stainless steels generally give deposits having higher proof stress values than those of the annealed parent metals and are, therefore, suitable for welding the high-proof strength grades since they generally meet the minimum strength requirements of the latter.

The presence of nitrogen in the high-

proof-strength steels promotes austenite formation. In welds with high heat input where the base metal has a greater dilution effect on the weld metal, due consideration must be given to this effect to ensure that the deposited weld metal contains a small amount of delta ferrite, this being the normal practice in welding austenitic steels in order to avoid hot cracking in the weld metal. This precaution is particularly important in welds having high restraint. In such cases a welding filler wire should be selected having a chromium-nickel balance which favours greater amounts of ferrite in the weld deposit. In the case of autogenous welding in which no filler wire is used, it has been suggested in some quarters

that modified grades of high proof stress nitrogen-containing steels should be developed to avoid the possibility of cracking. However, with autogenous welding of thin material the constraints are generally less than with thicker sections and this form of welding is not entirely ruled out for the high proof stress steels currently available although greater care has to be exercised in its use.

Notwithstanding the foregoing remarks relating to precautions that might sometimes be necessary in the welding of high proof stress austenitic stainless steel, it should be reiterated that in many cases fully satisfactory welds are obtained by using the same welding procedures and welding consumables

as those used for welding the conventional types of stainless steel.

Properties of welded joints

Weldments of the chromium-nickel stainless steels have good properties at low temperatures. As an example, Table 25 gives the tensile properties of joints made by manual metal-arc welding in 13 mm (½ inch) thick plates of the low-nitrogen standard types of stainless steel, whilst Table 26 gives typical data for weld joints in highproof-stress stainless steels.

Low-temperature impact data for welds in the conventional and high-proof-stress grades are presented in Tables 27, 28 and 30. Table 29 provides all-weld-metal impact test data.

Physical properties

Physical properties of the wrought and cast conventional grades of stainless steel at room temperature are given in Tables 31 and 32, respectively.

With decrease of temperature below room temperature, density increases markedly as shown in Figure 29. On the other hand, specific heat, thermal expansion coefficient, thermal conductivity and electrical resistivity decrease with falling temperature; see Figures 30-35.

Thermal expansion is an important property in the design of structures for low-temperature service and therefore data are presented in two different forms. Table 33 gives the mean linear coefficients for several steels between 20°C and various sub-zero temperatures, whilst Figures 32-34 show the actual expansions (or contractions) that will occur between any two temperatures below room temperature.

The physical properties of nitrogen-strengthened high-proof-stress stainless steels are generally similar to those of the conventional grades. However, the addition of nitrogen increases austenite stability at low temperatures and this results in retention of low magnetic permeability (μ) at temperatures down to -269°C, whereas the conventional stainless steep may show small increases in magnetic permeability when cooled to very low temperatures as shown in Table 31. The available evidence indicates that, in general, Types 316 and

316L are superior to Types 304 and 304L in resisting the effects of low temperature on magnetic permeability, while Types 347 and 321 are inferior. However, the relative magnetic stabilities of individual casts of different types of steel are dependent not only on the steel type, but also on the small variations in composition encountered within each specification range.

Low magnetic permeability is of special importance in certain cryogenic applications; for example, in superconducting motors and magnets, or in hydrogen bubble chambers where μ values below 1.03 are required at very high magnetic field strengths. However, the latter are well in excess of those giving maximum magnetic permeability in conventional austenitic stainless steels; in consequence the μ values of these steels under hydrogen bubble chamber service conditions are reduced to relatively low values as shown in the sixth column of Table 31. Nevertheless, the greater stability of austenite in the nitrogen-strengthened steels gives them some advantage in comparison with the conventional grades for hydrogen bubble chambers and other cryogenic applications requiring non-magnetic materials, since their magnetic permeability values are generally significantly lower than those of the conventional stainless steels for given service conditions of magnetizing force and temperature.

Table 1a. ASTM and ASME specifications for various forms of austenitic stainless steels (AISI Types 303, 303Se, 304, 304L, 316, 316L, 321 and 347).

Form of product	ASTM specification	ASME specification
Plates	A240-69	SA-240:68
Forgings	A473-63	SA-182:68
Bars and sections	A479-63	SA-479:68
Seamless tubes	A213-66	SA-213:68
Welded tubes	A249-65	SA-249:68
Seamless and welded tubes	A269-69	—
Seamless and welded tubes < ½in (13mm) O.D. and <0.065 in (1.9 mm) wall thickness	A632-69	—
Bolts, screws, studs, stud bolts	A320-70	SA-320:70
Nuts for bolts	A194-69	SA-194:69

Table 1b. Continued.

AISI steel type	Composition shown is for all specifications listed in Table 1 a except as indicated below	Composition. Weight per cent.										
		Variation in specific elements with change in product form is shown where necessary										
		C max	Si max	Mn max	Ni	Cr	Mo	Ti min	Nb or Nb+Ta min	S max	P max	Other
321		0.08	1.0	2.0	9.0–12.0	17.0–19.0	–	5 × C 0.7 max	–	0.030	0.045	
	SA-182		0.85		9.0 min	17.0–20.0		5 × C 0.6 max			0.035	
	SA-213 A249 SA-249 A632		0.75		9.0–13.0	17.0–20.0		5 × C 0.6 max			0.030	
	A269		0.75		9.0–13.0	17.0–20.0		5 × C 0.6 max			0.040	
	A473 A479 SA-479 A320							5 × C no max				
347		0.08	1.0	2.0	9.0–13.0	17.0–19.0	–	–	10 × C 1.10 max	0.030	0.045	
	SA-182								10 × C 1.0 max		0.030	
	A213 SA-213 A249 SA-249 A632		0.75			17.0–20.0			10 × C 1.0 max		0.030	
	A269		0.75			17.0–20.0			10 × C 1.0 max		0.040	
	A473 A479 SA-479 A320								10 × C no max			

(1) Carbon is 0.040 max for tube < 0.5 in. (13 mm) O.D. or wall thickness < 0.049 in (1.2 mm) average or < 0.044 in (1.1 mm) minimum.

Table 1c. Mechanical properties quoted in the ASTM and ASME specifications listed in Table 1a. (See also Table 1d)
(Minimum values at room temperature except where stated otherwise).

AISI steel type	Specification (see table 1a)	0.2% Proof stress			Tensile strength			Elongation %		Reduction of area %	HB max	Impact test ⁽⁴⁾	Inter-crystalline corrosion test
		N/mm ²	tonf/in ²	* 1C ³ lbf/in ² or (kgf/mm ²)	N/mm ²	tonf/in ²	* 1C ³ lbf/in ² or (kgf/mm ²)	on 2 in (51mm)	on 4D				
304 ⁽¹⁾	A240, SA240	210	13.5	(21.0)	520	33.5	(53-0)	40		-	202	No	(5)
	A473	210	13.5	30	520	33.5	75	-	40	50	-	No	(6)
	SA182	210	13.5	30	520	33.5	75 ⁽²⁾	-	45	50	-	No	(6)
	A479, SA479	210	13.5	(21.0)	520	33.5	(53.0)	-	40	50	202	No	(5)
	A213, SA213 ⁽⁶⁾	210	13.5	30 ⁽³⁾	520	33.5	75	35 ⁽³⁾		-	90 RB	No	(6)
	A249, SA249 ⁽⁶⁾	210	13.5	30 ⁽³⁾	520	33.5	75	35 ⁽³⁾		-	90 RB	No	(6)
	A269 ⁽⁶⁾	-	-	-	-	-	-	-	-	-	90 RB	No	(6)
A632 ⁽⁶⁾	210	13.5	30 ⁽³⁾	520	33.5	75	35 ⁽³⁾		-	-	No	(5)	
304L ⁽¹⁾	A240, SA240	170	11	(17.5)	480	31	(49.0)	40		-	202	No	(7)
	A473	170	11	25	450	29	65	-	40	50	-	No	(6)
	SA182	170	11	25	450	29	65	-	30	50	-	No	(6)
	A479, SA479	170	11	(17.5)	480	31	(49.0)	-	40	50	202	No	(7)
	A213, SA213 ⁽⁶⁾	170	11	25 ⁽³⁾	480	31	70	35 ⁽³⁾		-	90 RB	No	(6)
	A249, SA249 ⁽⁶⁾	170	11	25 ⁽³⁾	480	31	70	35 ⁽³⁾		-	90 RB	No	(6)
	A269 ⁽⁶⁾	-	-	-	-	-	-	-	-	-	90 RB	No	(6)
A632 ⁽⁶⁾	170	11	25 ⁽³⁾	480	31	70	35 ⁽³⁾		-	-	No	(7)	
316 ⁽¹⁾	A240, SA240	210	13.5	(21.0)	520	33.5	(53.0)	40		-	217	No	(5)
	A473	210	13.5	30	520	33.5	75	-	40	50	-	No	(6)
	SA182	210	13.5	30	520	33.5	75 ⁽²⁾	-	45	50	-	No	(6)
	A479, SA479	210	13.5	(21.0)	520	33.5	(53.0)	-	40	50	217	No	(5)
	A213, SA213 ⁽⁶⁾	210	13.5	30 ⁽³⁾	520	33.5	75	35 ⁽³⁾		-	90 RB	No	(6)
	A249, SA249 ⁽⁶⁾	210	13.5	30 ⁽³⁾	520	33.5	75	35 ⁽³⁾		-	90 RB	No	(6)
	A269 ⁽⁶⁾	-	-	-	-	-	-	-	-	-	90 RB	No	(6)
A632 ⁽⁶⁾	210	13.5	30 ⁽³⁾	520	33.5	75	35 ⁽³⁾		-	-	No	(5)	
316L ⁽¹⁾	A240, SA240	170	11	(17.5)	480	31	(49.0)	40		-	217	No	(7)
	A473	170	11	25	450	29	65	-	40	50	-	No	(6)
	SA182	170	11	25	450	29	65	-	30	50	-	No	(6)
	A479, SA479	170	11	(17.5)	480	31	(49.0)	-	40	50	217	No	(7)
	A213, SA213 ⁽⁶⁾	170	11	25 ⁽³⁾	480	31	70	35 ⁽³⁾		-	90 RB	No	(6)
	A249, SA249 ⁽⁶⁾	170	11	25 ⁽³⁾	480	31	70	35 ⁽³⁾		-	90 RB	No	(6)
	A269 ⁽⁶⁾	-	-	-	-	-	-	-	-	-	90 RB	No	(6)
A632 ⁽⁶⁾	170	11	25 ⁽³⁾	480	31	70	35 ⁽³⁾		-	-	No	(7)	
321 ⁽¹⁾ and 347 ⁽¹⁾	A240, SA240	210	13.5	(21.0)	520	33.5	(53.0)	40		-	202	No	(7)
	A473	210	13.5	30	520	33.5	75	-	40	50	-	No	(6)
	SA182	210	13.5	30	520	33.5	75 ⁽²⁾	-	45	50	-	No	(6)
	A479, SA479	210	13.5	(21.0)	520	33.5	(53.0)	-	40	50	202	No	(7)
	A213, SA213 ⁽⁶⁾	210	13.5	30 ⁽³⁾	520	33.5	75	35 ⁽³⁾	-	-	90 RB	No	(6)
	A249, SA249 ⁽⁶⁾	210	13.5	30 ⁽³⁾	520	33.5	75	35 ⁽³⁾		-	90 RB	No	(6)
	A269 ⁽⁶⁾	-	-	-	-	-	-	-	-	-	90 RB	No	(6)
A632 ⁽⁶⁾	210	13.5	30 ⁽³⁾	520	33.5	75	35 ⁽³⁾		-	-	No	(7)	

Table 1d. Mechanical properties quoted in ASTM specifications A 194 and A320 for austenitic stainless steel fasteners. (Minimum values at room temperature).

AISI steel type	Specification and steel grade	Condition	Diameter		0.2% proof stress			Tensile strength			Elongation Lo=2 in (51 mm) %	Reduction of area %
			inch	mm	N/mm ²	tonf/in ²	*10 ³ lbf/in ² (kgf/mm ²)	N/mm ²	tonf/in ²	*10 ³ lbf/in ² (kgf/mm ²)		
303 303Se 304	A194 Grade 8F ⁽²⁾	Carbide solution treated ⁽¹⁾	-	-	-	-	-	-	-	-	-	-
316	A194 Grade 8M ⁽²⁾											
321	A194 Grade 8T ⁽²⁾											
347	A194 Grade 8C ⁽³⁾											
303 303Se 304	A320 Grade B8F ⁽²⁾											
316	A320 Grade B8 ⁽³⁾											
321	A320 Grade B8M ⁽²⁾											
347	A320 Grade B8T ⁽²⁾											
347	A320 Grade B8C ⁽³⁾											
303 303Se 304	A320 Grade 138F ⁽²⁾	Carbide solution treated and strain hardened	< 3/4	< 19	690	44.5	100 (70.3)	860	56	125 (87.9)	12	35
304	A320 Grade B8		> 3/4	> 19	550	35.5	80 (56.2)	790	51.5	115 (80.9)	15	35
316	A320 Grade B8M ⁽²⁾		< 1	< 25	450	29	65 (45.6)	720	47	105 (73.8)	20	35
321	A320 Grade B8T ⁽²⁾		> 1	> 25	340	22.5	0 (35.1)	690	44.5	100 (70.3)	28	45
347	A320 Grade B8C		< 1/4	< 32								

*Other values converted from this unit.

(1) When increased mechanical properties are desirable nuts may be machined from cold drawn bars without subsequent carbide solution treatment.

(2) An impact test is not required for use at temperatures above -198°C.

(3) An impact test is not required for use at temperatures above -254°C.

Footnotes for Table 1c, page 8.

*Other values converted from this unit.

(1) Heat treatment condition: A240, SA240, A479, SA479-heat treated to satisfy mechanical property requirements, this normally comprises annealing at 1000-1120°C water-quenched or air-cooled.

A473, SA182-annealed at 1040°C min., WQ or AC.

A213, SA213, A249. SA249, A269-annealed at 1040°C min, WQ or rapidly cooled by other means

A632-annealed at 982°C min, WQ or rapidly cooled by other means.

(2) Reduced to 70 x 10³ lbf/in² for sections over 5 in thickness.

(3) Proof stress, or yield stress, is not required for tubes < 0.125 in (3.2 mm) diameter, or < 0.015 in (0.4 mm) wall thickness, and the elongation is reduced to 25% min.

(4) See Table 18 for impact test requirements of austenitic stainless steels in the ASME Boiler and Pressure Vessel Code.

(5) Intercrystalline corrosion test is not specified but may be requested by the purchaser on unsensitized material.

(6) Intercrystalline corrosion test is not specified.

(7) Intercrystalline corrosion test is not specified, but may be requested by the purchaser on material sensitized 1 hour at 675°C.

(8) All tube specifications require a hydrostatic or non-destructive electric test. Some tube specifications require a flattening test and/or reverse bend test.

Table 2a. British Standards for various forms of wrought austenitic stainless steels suitable for use at low temperatures.

Nearest AISI steel type	Steel designations in British Standards for various product forms.						
	BS1501: Part 3:1973 Plates	BS1501: 1958 ⁽¹⁾ Bars and Sections	BS1503 : 1969 (amended 1973) Forgings	BS1506: 1958 Bolting bars	BS4882 : 1973 Bolts and nuts ⁽²⁾	BS3605:1973 Pipes and tubes Seamless Welded	
304	304S15	801LT190 Grade B	304S40	801 LT190 Grade B	Steel to BS1506-801 Grade B for Bolts, grades L8, L8, L8X, L8X M M and Nuts, grades 8F, 8F, 8FX, 8FX M M	304S18	304S25
304L	304S12	801LT190 Grade C	304S30	801LT190 Grade C	- Steel to BS1506-845 for Bolts, grades L8M, L8M, L8MX, L8MX	304S14	304S22
316	316S16	845LT190 Grade B	316S40 316S41	845LT190	M M and Nuts, grades 8M, 8M, 8MX, 8MX M M	316S18	316S26
316L	316S12 316S37	-	316S30 316S31	-	-	316S14	316S22
(316Ti)	320S17	845LT190 Grade Ti	320S40	-	-	-	-
321	321S12	821Ti LT190	321S40	821Ti LT190	Steel to BS1506-821 Grade Ti for Bolts, grades L8T, L8T, L8TX, L8TX M M and Nuts, grades 8T, 8T, 8TX, 8TX M M	321S18	321S22
347	347S17	821 Nb LT190	347S40	821 Nb LT190	Steel to BS1506-821 Grade Nb for Bolts, grades L8C, ILK, L8CX, L8CX M M and Nuts, grades 8C, 8C, 8CX, 8CX M M	347S18	347S17

(1) To be replaced by BS 1502.

(2) The suffix letter M in some grade designations denotes metric dimensions, and the letter X denotes products of cold worked material.

Table 2b. Chemical compositions quoted in British Standards for the austenitic stainless steels listed in Table 2a.

Nearest AISI steel type	British Standard	Steel designation	Composition. Weight percent.										
			C	Si	Mn	Ni	Cr	Mo	Ti	Nb or Nb+Ta	S	P	
			max							min	min	max	max
304	BS1501:Part 3:1973	304S15	0.06	0.2- 1.0	0.5- 2.0	8.0- 11.0	17.5- 19.0	-	-	-	-	0.030	0.045
	BS1501-06:1958 BS4882: 1973	801LT190 Grade B Steel to BS1506-801 Grade B	0.08	0.2 min	2.0 max	8.0- 11.0	17.5- 20.0	-	-	-	-	0.045	0.045
	BS1503:1969	304S40	0.07	1.0 max	2.0 max	8.0- 12.0	17.0- 19.0	-	-	-	-	0.030	0.045
	BS3605: 1973	304S18 304S25	0.06	0.2- 1.0	0.5- 2.0	8.0- 11.0	17.0- 19.0	-	-	-	-	0.030	0.045
304L	BS1501: Part 3: 1973	304S72	0.03	0.2- 1.0	0.5- 2.0	9.0- 11.0	17.5- 19.0	-	-	-	-	0.030	0.045
	BS1501-06:1958	801LT190 Grade C	0.03	0.2- 1.0	0.5- 2.0	10.0 min	17.5- 20.0	-	-	-	-	0.045	0.045
	BS1503:1969	304S30	0.03	1.0 max	2.0 max	9.0- 13.0	17.0- 19.0	-	-	-	-	0.030	0.045
	BS3605:1973	304S14 304S22	0.03	0.2- 1.0	0.5- 2.0	10.0- 13.0	17.0- 19.0	-	-	-	-	0.030	0.040

Table 2b. Continued.

Nearest AISI steel type	British Standard	Steel designation	Composition, Weight percent.										
			C	Si	Mn	Ni	Cr	Mo	Ti	Nb or Nb + Ta	S	P	
			max						min	min	max	max	
316	BS1501 :Part 3 :1973	316S16	0.07	0.2 1.0	0.5 2.0	10.0- 13.0	16.5- 18.5	225- 3.0			0.030	0045	
	BS1501 : 1958	845LT190 Grade B	0.08	0.2- 1.0	2.0 max	10.0 min	16.5- 18.5	2.25- 3.0	-	-	0.045	0045	
	BS1503 : 1969	316S40	0.07	1.0 max	2.0 max	10.5- 14.0	16.0- 18.5	2.0- 2.5	-	-	0030	0045	
		316S41	0.07	1.0 max	2.0 max	11.0- 14.5	16.0- 18.5	2.5- 3.0	-	-	0.030	0.045	
	BS1506:1958	845LT190	0.08	0.2- 1.0	2.0 max	10.0 min	160- 18.0	2.5- 3.0	-	-	0.050	0050	
	BS4882: 1973	Steel to BS1506-845											
	BS3605:1973	316S18	0.07	0.2- 1.0	0.5- 2.0	11.0- 14.0	16.0- 18.5	2.0- 3.0	-	-	0.030	0040	
		316S26	0.07	0.2- 1.0	0.5- 2.0	10.0- 13.0	16.0- 18.5	2.0- 3.0	-	-	0.030	0.040	
316L	BS1501 : Part 3: 1973	316S72	0.03	0.2- 1.0	0.5- 2.0	11.0- 14.0	16.5- 18.5	2-25- 3.0	-	-	0.030	0.045	
		316S37	0.03	0.2- 1.0	0.5- 2.0	13.0- 15.0	16.5- 18.0	225- 3.0	-	-	0.030	0.040	
	BS1503:1969	316S30	0.03	1.0 max	2.0 max	11.0- 14.0	16.0- 18.5	2.0- 2.5	-	-	0.030	0.045	
		316S31	0.03	1.0 max	2.0 max	11.5- 14.5	16.0 18.5	2.5- 3.0	-	-	0.030	0.045	
	BS3605:1973	316S14	0.03	0.2- 1.0	0.5- 2.0	12.0- 15.0	16.0- 18.5	2.0- 3.0	-	-	0.030	0.040	
		316S22	0.03	0.2- 1.0	0.5- 2.0	11.0- 14.0	16.0- 18.5	2.0- 3.0	-	-	0.030	0.040	
	(316 Ti)	BS1501 : Part 3 :1973	320S17	0.08	0.2- 1.0	0.5- 2.0	11.0- 14.0	16.5- 18.5	2-25- 3.0	4 x C 0.6 max		0.030	0.045
		BS1501 : 1958	845LT190 Grade Ti	0.08	0.2- 0.6	2.0 max	10.0 min	16.5- 18.5	2-25- 3.0	4 x C 0.5 max		0.050	0.050
BS1503 : 1969		320S40	0.08	1.0 max	2.0 max	11.0- 15.0	16.5- 18.5	225- 3.0	5 x C 0.7 max	-	0.030	0.045	
321	BS1501:Part 3:1973	321S12	0.08	0.2- 1.0	0.5- 2.0	9.0- 12.0	17.0- 19.0	-	5XC 0.7 max	-	0.030	0.045	
	BS1501.06:1958	821 Ti LT190	0.12	0.2- 1.0	0.5- 2.0	7.5 min Ni+Cr	17.0- 20.0 25.0 min	-	4 x C 0-7 max	-	0.045	0.045	
	BS4882: 1973	Steel to BS1506-821 Grade Ti											
	BS1503 : 1969	321S40	0.08	1.0 max	2.0 max	9.0- 13.0	17.0- 19.0	-	5 x C 0.7 max	-	0.030	0.045	
	BS3605:1973	321S18	0.08	0.2- 1.0	0.5 2.0	10.0- 13.0	17.0- 19.0	-	5xC 0.6 max	-	0.030	0.040	
321S22		0.08	0.2- 1.0	0.5- 2.0	9.0- 12.0	17.0- 19.0	-	5xC 0.6 max	-	0.030	0.040		
347	BS1501 : Part 3:1973	347S17	0.08	0.2- 1.0	0.5 2.0	9.0 12.0	17.0- 19.0		-	10xC 1.0 max	0.030	0.045	
	BS1501- 6:1958	821NbLT190	0.08	0.2- 1.0	0.5- 2.0	9.0 min	17.0- 20.0	-	-	10x C 1.0 max	0.045	0.045	
	BS4882: 1973	Steel to BS1506-821 Grade Nb											
	BS1503:1969	347S40	0.08	1.0 max	2.0 max	9.0- 13.0	17.0- 19.0	-	-	10xC 1.0 max	0.030	0.045	
	BS3605:1973	347S18	0.08	0.2- 1.0	0.5- 2.0	10.0- 13.0	17.0- 19.0	-	-	10XC (20xC or 1.0* max)	0.030	0.030	
347S17									10 x C				

Table 2c. Mechanical properties quoted in British Standards for the steels listed in Table 2a (see also Table 2d).
(Room-temperature values, except where stated otherwise).

Nearest AISI steel type	British Standard	Steel designation	0.5% proof stress min		1.0% proof stress min		Tensile strength min		Elongation % min			Charpy V-notch impact value at -190°C min (3)				Inter- crystalline corrosion test (10)
			N/mm ²	*	N/mm ²	*	N/mm ²	*	(1)	(2)	(2)					
			(kgf/mm ²)	tonf/in ²	(kgf/mm ²)	tonf/in ²	(kgf/mm ²)	tonf/in ²	Lo=2 in (51 mm)	Lo= 3.54D	Lo= 5.65% Lo					
304 ⁽⁴⁾	BSI 501 :Part 3: 1973 ⁽⁹⁾	304S15	215 ⁽⁶⁾ (22)	14.0 ⁽⁶⁾ (2)	245 (25)	16.0	510 (52)	33.0	40	-	40	See footnote ⁽⁸⁾				Optional (15 minutes)
	BS1501 :1958	801 LT190 Grade B	210 (22)	13.5	-	-	540 (55)	35.0	25	30	-	27	3.4	20	3.5	Mandatory (not sensitized)
	BS1506 :1958	801 LT190 Grade S	210 (22)	13.5	-	-	540 (55)	35.0	-	30	-	27	3.4	20	3.5	Mandatory (not sensitized)
	BS1503:1969	304S40	195 ⁽⁶⁾ (20)	12.6 ⁽⁶⁾	235 (24)	152	510 (52)	33.0	-	-	L T 35 30	-	-	-	-	Optional (not sensitized)
	BS3605:1973	304S18 304S2S	-	-	2354 (24)	152	490-690* (50-70)	31.7- 44.7	-	-	L T 35 25	See footnotes ^{(8) & (7)}				Optional (15 minutes)
304L ⁽⁴⁾	BS1601 :Part 3: 1973 ⁽⁹⁾	304S12	200 ⁽⁶⁾ (20)	13.0 ⁽⁶⁾	230 (24)	150	490 (50)	32.0	40	-	40	See footnote ⁽⁸⁾				Optional (30 minutes)
	BS1501 :1958	801 LT790 Grade C	200 (20)	13.0	-	-	510 (52)	33.0	25	30	-	27	3.4	20	3.5	Mandatory (30 minutes)
	BS1506 :1958	801 LT190 Grade C	200 (20)	13.0	-	-	510 (62)	33.0	-	30	-	27	3.4	20	3.5	Mandatory (30 minutes)
	BS1503 :1969	304S30	175 ⁽⁶⁾ (18)	113 ⁽⁶⁾	205 (21)	133	490 (50)	32.0	-	-	L T 35 30	-	-	-	-	Optional (30 minutes)
	BS3605 :1973	304S74 304S22	-	-	205* (21)	133	490-690* (50-70)	31.7- 44.7	-	-	L T 35 25	Sea footnotes ^{(8) & (7)}				Optional (30 minutes)
316 ⁽⁴⁾	BS1501 :Part 3: 1973(x)	316S76	230 ⁽⁶⁾ (24)	150 ⁽⁶⁾	260 (27)	17.0	530 (54)	34.0	40	-	40	See footnote ⁽⁸⁾				Optional (15 minutes)
	SS1501 :1958	845LT190 Grade B	210 (21)	13.5	-	-	540 (55)	35.0	25	30	-	27	3.4	20	3.5	Mandatory (30 minutes)
	BS1506 :1958	845LT190	210 (21)	13.5	-	-	640 (55)	35.0	-	30	-	27	3.4	20	3.5	Mandatory (30 minutes)
	BS1503 :1969	316S40 316S41	205 ⁽⁶⁾ (21)	13.3 ⁽⁶⁾	245 (25)	15-9	510 (52)	33.0	-	-	L T 35 30	-	-	-	-	Optional (not sensitized)
	BS3605 :1973	316S78 316S26	-	-	245* (25)	15-9	510-710* (52-72)	33.0- 46.0	-	-	L T 35 25	Sea footnotes ^{(8) & (7)}				Optional (15 minutes)
316L ⁽⁴⁾	BS1501 : Part 3 1973 ⁽⁹⁾	316S12 316S37	216 ⁽⁶⁾ (22)	140 ⁽⁶⁾	245 (25)	160	610 (52)	33.0	40	-	40	See footnote ⁽⁸⁾				Optional (30 minutes)
	BS1503:1969	316S30 316S31	185 ⁽⁶⁾ (19)	12.001	215 (22)	13-9	490 (60)	32.0	-	-	L T 35 30	-	-	-	-	Optional (30 minutes)
	BS3605:1973	316S74 316S22	-	-	215* (22)	13-9	490-690* (50-70)	31.7- 44.7	-	-	L T 35 25	Sea footnotes ^{(8) & (7)}				Optional (30 minutes)
316Ti ⁽⁴⁾	BS7501 :Part 3: 1973 ⁽⁹⁾	320S77	240 ⁽⁶⁾ (24)	15.5 ⁽⁶⁾	270 (28)	17.5	530 (54)	34.0	40	-	40	See footnote ⁽⁸⁾				Optional (30 minutes)
	BS1601 :1958	845LT1904 Grade Ti	210 (21)	133	-	-	540 (55)	35.0	25	30	-	27	3.4	20	3.5	Mandatory (30 minutes)
	BS7603 :1969	320S40	210 ⁽⁶⁾ (21)	13.6 ⁽⁶⁾	240 (24)	15.5	510 (52)	33.0	-	-	L T 35 30	-	-	-	-	Optional (30 minutes)
321 ⁽⁵⁾	BS1501 :Part 3: 1973 ⁽⁹⁾	321S12 <¼ in (20 mm) thick >¼ in (20 mm)	240 ⁽⁶⁾ (24)	15.5	280 (28)	18.0	540 (65)	35.0	40	-	40	See footnote ⁽⁸⁾				Optional (30 minutes)
	BS1501 :1958	821 Ti LT790	210 (21)	13.6	-	-	540 (55)	35.0	25	30	-	27	3.4	20	3.5	Mandatory (30 minutes)
	SS1606:1958	821TiLT190	210 (21)	13.5	-	-	540 (55)	35.0	-	30	-	27	3.4	20	3.5	Mandatory (30 minutes)
	BS1503:1969	321S40	195 ⁽⁶⁾ (20)	12.6 ⁽⁶⁾	235 (24)	152	510 (52)	33.0	-	-	L T 35 30	-	-	-	-	Optional (30 minutes)
	BS3605:1973	321S18 321S22	-	-	235* (24)	16-2	610-710* (52-72)	33.0- 46.0	-	-	L T 35 25	Sea footnotes ^{(8) & (7)}				Optional (30 minutes)
347 ⁽⁵⁾	BS1501 :Part 3: 1973 ⁽⁹⁾	347S17 <¼ in (20 mm) thick >¼ in (20 mm)	240 ⁽⁶⁾ (24)	15.5 ⁽⁶⁾	280 (28)	18.0	540 (55)	35.0	40	-	40	See footnote ⁽⁸⁾				Optional (30 minutes)
	BS1501:1958	821Nb LT190	210 (21)	13.5	-	-	540 (55)	35.0	25	30	-	27	3.4	20	3.5	Mandatory (30 minutes)
	BS1506:1958	821 Nb LT190	210 (21)	13.5	-	-	540 (55)	35.0	-	30	-	27	3.4	20	3.5	Mandatory (30 minutes)
	BS1503:1969	347S40	205 ⁽⁶⁾ (21)	13.3 ⁽⁶⁾	245 (25)	15-9	510 (52)	33.0	-	-	L T 35 30	-	-	-	-	Optional (30 minutes)
	BS3605: 1973	347S18 347S17	-	-	245* (25)	15-9	510-710* (52-72)	33.0- 46.0	-	-	L T 35 25	Sea footnotes ^{(8) & (7)}				Optional (30 minutes)

* Other values converted from this unit, except for BS3605 steels for which the mandatory value is given in SI units.

(1) Rectangular test-piece.

(2) Round test-piece.

(3) Impact values specified in BS1510: 1958 'Low-temperature supplementary requirements to BS1501-1506:1958'. Average of three tests. The minimum individual test value is 5 ft lbf less.

	BS1501 :Part 3 :1973	BS1501-06 :1958	BS1503 :1969	BS3605 :1973	WQ QQ or AC
(4) Heat treatment condition. Annealed:	1000-1120°C	1000-1100°C	950-1100°C	1000-1100°C	
(5) Heat treatment condition. Annealed:	980-1050°C	1000-1100°C	950-1100°C	1000-1100°C	

(6) 0.2% proof stress.

(7) A ring flattening test or bend test at room temperature is required: a hydraulic pressure test may also be requested by the purchaser.

(8) The BS 1501 : Part 3 : 1973 and SS3605 : 1973 specifications state that the austenitic stainless steels are not notch sensitive at temperatures down to -196 °C and that has not been considered necessary to include low temperature impact values for these steels in the specifications.

(9) The BS 1501 : Part 3 : 1973 specification applies to plates <2 in (51 mm) thick.

(10) Unless stated otherwise the intercrystalline corrosion test is to be made on material sensitized at 650°C for the time given in parentheses.

Table 2d. Mechanical properties quoted in British Standard BS4882 : 1973 for austenitic stainless steel bolts and nuts specified for use down to -250 °C.

(Minimum values)

Nearest AISI steel type	BS4882: 1973 Steel designation	Bolt grade designation		Corres- ponding Nut grade designation		Section size		Tensile properties(1)						Hardness		Charpy V- notch Impact value		
		Metric series	Inch series	Metric series	Inch series	mm	inch	0.2% proof stress			tensile strength			Elongation Lo=5.65√So %	H _v max.	H _B max.	J* (kgf/cm ²)	(3) ft lbf
								*	(3)		*	(3)						
Solution treated 1000°C to 1100°C WQ																		
304	BS1506 -8018	L8 M	L8	8F M	8F	<19	<¾	210	13.5	21	540	35	55	35	193	183	20 ⁽²⁾ (2.5)	15 ⁽²⁾
316	BS1506 -845	L8M M	L8M	8M M	8M													
321	BS1506 -821 Ti	L8T M	L8T	8T M	8T													
347	BS1506 -821Nb	L8C MI	L8C	8C M	8C													
Cold worked after solution treatment																		
304	BS1506 -8018	L8X M	L8X	8FX M	8FX	<19	<¾	700	45	71	860	56	89	12	369	350	20 ⁽²⁾ (2.5)	15 ⁽²⁾
316	BS1506 -845	L8MX M	L8MX	8MX M	8MX	>20 <24	>¾ <1	550	36	56	790	51	81	15	-	-	-	-
						>24 <30	>1 <1¼	450	29	46	720	47	73	20	-	-	-	-
321	BS1506 -821 Ti	L8TX M	L8TX	8TX M	8TX	>30 <36	>1¼ <1½	340	22	35	700	45	71	28	-	-	-	-
						>36 <42	>1½ <1¾	310	20	32	650	42	66	28	-	-	-	-
347	BS1506 -821 Nb	L8CX M	L8CX	8CX M	8CX	>36 <42	>1½ <1¾	310	20	32	650	42	66	28	-	-	-	-

*Other values converted from this unit except (3).

(1) Tensile properties are specified for bolt material only.

(2) Impact values specified are only required below -200 °C. No impact test specified for higher temperatures.

(3) Values in this unit are also given in the specification.

Table 3a. Chemical compositions of austenitic stainless steels suitable for use at low temperatures. German specification for all wrought product forms.

Nearest AISI steel type	Specification and steel designation	Werkstoff number	Composition. Weight per cent.										
			C max	Si max	Mn max	Ni	Cr	MO	Ti min	Nb min	S max	P max	
	SEW 680-70												
302	X12 Cr Ni 18 9	16900	0.12	1.0	2.0	8.0- 10.0	17.0- 19.0	0.5 max	-	-	0.030	0.045	
304	X5 Cr Ni 18 10	1.6906	0.07	1.0	2.0	9.0- 11.5	17.0- 19.0	0.5 max	-	-	0.030	0.045	
321	X10 Cr Ni Ti 18 10	1.6903	0.10	1.0	2.0	10.0- 12.0	17.0- 19.0	0.5 max	5xC 0.8 max	-	0.030	0.045	
347	X10 Cr Ni Nb 18 10	16905	0.10	1.0	2.0	10.0- 12.0	17.0- 19.0	0.5 max	-	8xC 0.1 max	0.030	0.045	
	DIN 17440-72												
304	X5 Cr Ni 18 9	1.4301	0.07	1.0	2.0	8.5- 10.0 ⁽²⁾	7.0- 20.0	-	-	-	-	-	
304	X5 Cr Ni 19 11	1.4303	0.07	1.0	2.0	10.5- 12.0	17.0- 20.0	-	-	-	-	-	
304L	X2 Cr Ni 18 9	1.4306	0.03	1.0	2.0	10.0- 12.5	17.0- 20.0	-	-	-	-	-	
321	X10 Cr Ni Ti 18 9	1.4541	0.10	1.0	2.0	9.0- 11.5	17.0- 19.0	-	5xC	-	-	-	
347	X10 Cr Ni Nb 18 9	1.4550	0.10	1.0	2.0	9.0- 11.5	17.0- 19.0	-	-	8xC (or Ta 16xC)	-	-	
316	X5 Cr Ni Mo 18 10	1.4401	0.07	1.0	2.0	10.5- 13.5	16.5- 18.5	2.0- 2.5	-	-	-	-	
316L	X2 Cr Ni Mo 18 10	1.4404	0.03	1.0	2.0	11.0- 14.0	16.5- 18.5	2.0- 2.5	-	-	-	-	
(316 Ti)	X10 Cr Ni Mo Ti 18 10	1.4571	0.10	1.0	2.0	10.5- 13.5	16.5- 18.5	2.0- 2.5	5xC	-	-	-	
(316 Nb)	X10 Cr Ni Mo Nb 18 10	1.4580	0.10	1.0	2.0	10.5- 13.5	16.5- 18.5	2.0- 2.5	-	8x C (or Ta 16xC)	-	-	
	DIN 267 Blatt 11:68⁽¹⁾	DIN 17440 Werkstoff Nr.											
304 or 321 316	A2	1.4301 or 1.4541 1.4401	See compositions given above.										
or (316 Ti)	A4	or 1.4571	See compositions given above.										

(1) Cold formed fasteners (bolts, screws and nuts).

(2) A minimum of 9% Ni may be agreed for pressure vessel material, while for seamless tube up to 10.5% Ni is allowed.

Table 3b. Mechanical properties quoted in German DIN 17440 Standard for austenitic stainless steels accepted by SEW 680-70 and A. D. Merkblatt W10 as suitable for use at low temperatures.

(Minimum guaranteed values, except where stated otherwise, for room-temperature tests)

Nearest AISI steel type	304	304	304L	321	347	316	316L	(316 Ti)	(316 Nb)	
Steel designation DIN 17440: 72	X5 Cr Ni 18 9	X5 Cr Ni 19 11	X2 Cr Ni 18 9	X10 Cr Ni Ti 18 9	X10 Cr Ni Nb 18 9	X5 Cr Ni Mo 18 10	X2 Cr Ni Mo 18 10	X10 Cr Ni Mo Ti 18 10	X10 Cr Ni Mo Nb 18 10	
Werkstoff Nr.	1.4301	1.4303	1.4306	1.4541	1.4550	1.4401	1.4404	1.4571	1.4580	
Accepted by A D Merkblatt W10 for use in pressure vessels down to at least:	-196 °C	-196 °C	-196 °C	-196 °C	-196 °C	-60 °C	-60 °C	-60 °C	-60 °C	
Condition: Annealed °C W.Q. or A.C. accord ing to thickness	1000-1050	1000-1050	1000-1050	1020-1070	1020-1070	1050-1100	1050-1100	1050-1100	1050-1100	
0.2% proof stress: *N/mm ² tonf/in ² kgf/mm ²	185 13 19	185 13 19	175 11 18	205 ⁽¹⁾ 13 21	205 13 21	205 13 21	195 13 20	225 ⁽¹⁾ 15 23	225 15 23	
1.0% proof stress: *N/mm ² tonf/in ² kgf/mm ²	225 15 23	225 15 23	215 14 22	245 ⁽¹⁾ 16 25	245 16 25	245 16 25	235 15 24	265 ⁽¹⁾ 17 27	265 17 27	
Tensile strength: *N/mm ² tonf/in ² kgf/mm ²	500-700 32.45 51-71	500-700 32.45 51-71	450-700 29.45 46-71	500-750 32.49 51-76	500-750 ⁽²⁾ 32.49 51-76	500-700 32.45 51-71	450-700 32.45 46-71	500-750 32.49 51-76	500-750 32.49 51-76	
Elongation Lo=5.65 √So Longit (a) (b) Transv. (c) (d)	50 45 37 34	50 45 37 34	50 45 37 34	40 35 30 26	40 35 30 26	45 40 34 30	45 40 34 30	40 35 30 26	40 35 30 26	
Hardness HB	130-160	130-180	120-180	130-190	130-190	130-180	120-180	130-190	130-190	
Impact strength	All steels									
	J*		da J/cm ²			kg fm		kg fm/cm ²		ft lbf
	Longit ⁽³⁾ DVM		85			12.1		8.7		12.4
Transv ⁽⁴⁾ DVM		55			7.9		5.6		8.0	41
Resistance to inter- crystalline corrosion ⁽⁵⁾	Required to be guaranteed in the as-supplied condition or as-welded									

*Other values converted from this unit.

(1) Value applies only up to 20mm wall thickness for tube. For rolled bars > 100 mm diameter the value shown is lowered by 10 N/mm². For extruded bars of any size the value shown is reduced by 20 N/mm² for steel 1.4541, and by 10 N/mm² for steel 1.4571.

(2) Tensile strength range is 500-800 N/mm² for strip ≥ 250 mm wide, or for wire.

(3) Plate >5 <50 mm thick. Bar and forgings < 160 mm diameter or thickness.

(4) Plate >5 <50 mm thick. Bar and forgings > 100 < 160 mm diameter or thickness.

For plate < 10 mm thick impact test-pieces of width = plate thickness are employed.

(5) For steels 1.4301, 1.4303 and 1.4401 intercrystalline corrosion resistance is to be guaranteed only for tube of wall thickness <6mm, or for bar of diameter <40 mm.

(a) Plate sheet, strip and tube < 10 mm thick. Bar and forgings <60 mm thickness or diameter.

(b) Plate sheet, strip and tube > 10 < 50 mm thick. Bar and forgings > 60 < 160 mm thickness or diameter.

(c) Plate sheet, strip and tube < 10 mm thick.

(d) Plate sheet, strip and tube > 10 < 50 mm thick. Bar and forgings > 100 < 160 mm thickness or diameter.

Table 3c. Mechanical properties quoted in SEW 680-70 for austenitic stainless steels suitable for use at low temperatures and accepted by A. D. Merkblatt W10 for use in pressure vessels down to at least $-253\text{ }^{\circ}\text{C}$
(Minimum values at room temperature except as stated otherwise).

Nearest AISI steel type	302	304	321	347
Steel designation	X12 Cr Ni	X5 Cr Ni	X10 Cr Ni Ti	X10 Cr Ni Nb
Werkstoff number	18-9 1.6900	18-10 1.6906	18-10 1.6903	18-10 1.6905
Condition: Annealed $^{\circ}\text{C}$ WQ or AC	1050-1100	1050-1100	1020-1070	1020-1070
0.2% proof stress N/mm ² tonf/in ² kgf/mm ^{2*}	220 14 22	190 12 19	210 13 21	210 13 21
1.0% proof stress N/mm ² tonf/in ² kgf/mm ^{2*}	250 17 26	230 15 23	250 16 25	250 16 25
Tensile strength N/mm ² tonf/in ² kgf/mm ^{2*}	490-690 32-44 50-70	490-690 32-44 50-70	490-740 32-48 50-75	490-740 32-48 50-75
Elongation % on 5.65 $\sqrt{S_0}$ (a) (b) (c)	50 45 40	50 45 40	40 35 30	40 35 30
Reduction of area % (a) (b) (c)	60 55 50	60 55 50	50 45 40	50 45 40
Impact strength	See Table 3d			
Mandatory inter-crystalline corrosion test	No	No	No	No

(a) }
(b) } See footnotes of Table 3b.
(c) }

*Other values converted from this unit.

Table 4a. Chemical compositions of wrought austenitic stainless steels suitable for use at low temperatures. French AFNOR specifications.

Nearest AISI steel type	AFNOR specification A36-209 : 70 Steel designation	Product form	Composition. Weight per cent.									
			C Max	Si Max	Mn Max	Ni	Cr	Mo	Ti Min	Nb or Nb + Ta min	S Max	P Max
304	Z6CN 18-09	Plate ≤20mm	0.07	1.0	2.0	8.0-10.0	17.0-19.0	-	-	-	0.030	0.040
304L	Z2CN 18-10	Plate ≤20mm	0.03	1.0	2.0	9.0-11.0	17.0-19.0	-	-	-	0.030	0.040
321	Z6CNT 18-11	Plate ≤20mm	0.08	1.0	2.0	10.0-12.0	17.0-19.0	-	5 × C 0.6 max	-	0.030	0.040
316L	Z2CND 17-12 ⁽¹⁾	Plate	0.03	1.0	2.0	11.0-13.0	16.0-18.0	2.0-2.5	-	-	0.030	0.040
(316 Ti)	Z8CNDT 17-12 ⁽¹⁾	Plate	0.10	1.0	2.0	11.0-13.0	16.0-18.0	2.0-2.5	either 5 × C 0.6 max	or 10 × C 1.0 max	0.030	0.040

(1) Steel included in an appendix to the specification without mandatory mechanical properties.

Table 4b. Mechanical properties of austenitic stainless steels suitable for use at low temperatures. French specifications for plate material ≤20mm thick.

(Minimum values at room temperature except as stated otherwise)

Nearest AISI steel type	304			304L			321			316L		(316 Ti)	
AFNOR specification	A36-209 : 70			A36-209 : 70			A36-209 : 70			A36-209 : 70		A36-209 : 70	
Steel designation	Z6CN 18-09			Z2CN 18-10			Z6CNT 18-11			Z2CND 17-12 ⁽¹⁾		Z8CNDT 17-12 ⁽¹⁾	
Condition: Annealed at °C and WQ	1025-1075			1025-1075			1050-1100			-		-	
0.2% proof stress N/mm ² *hbar tonf/in ² kgf/mm ²	(a) 210 21 13.5 21.5	(d) 200 20 13 20.5	(a) 190 19 12.5 19.5	(d) 180 18 11.5 18.5	(a) 220 22 14 22.5	(d) 200 20 13 20.5			200 20 13 20.5		240 24 15.5 24.5		
Tensile strength N/mm ² *hbar tonf/in ² kgf/mm ²	510-710 51-71 33-46 52-72			460-660 46-66 30-43 47-67			490-690 49-69 32-45 50-70			540 54 35 55		590 59 38 60	
Elongation. % on 5.65 √So	(a) 40	(b) 45	(c) 43	(a) 40	(b) 45	(c) 43	(a) 35	(b) 40	(c) 38	50		45	
Impact strength for plates up to 20mm thick:	Charpy		Charpy		Charpy		Charpy		Charpy		Charpy		
Type of test	U	V	U	V	U	V	V-notch		V-notch		V-notch		
Test temperature °C	+20	-196	+20	-196	+20	-196	+20	-196	+20	-196	+20	-196	
J *daJ/cm ² kgf m kgf m/cm ² ft lbf	60 12 6 12 44	80 10 ⁽²⁾ 8 10 59	60 12 6 12 44	80 10 ⁽²⁾ 8 10 59	60 12 6 12 44	72 9 ⁽²⁾ 7 9 53	160 20 16 20 118	120 15 12 15 89	160 20 16 20 118	120 15 12 15 89			
Mandatory intercrystalline corrosion test	No			No			No			No		No	

*Other values converted from this unit.

(1) Mechanical properties not mandatory.

(2) Average value. This is reduced by 2 daJ/cm², to give the minimum value for an individual test.

(a) Plate thickness < 3mm.

(b) Plate thickness 3-10mm.

(c) Plate thickness 10-20mm.

Table 5a. Italian UNI specifications for various forms of austenitic stainless steels suitable for use at low temperatures.

Nearest AISI steel type	Form of product	UNI speci- fication	Steel designation	Composition. Weight per cent									
				C Max	Si Max	Mn Max	Ni	Cr	Mo	Ti Min	Nb + Ta min	S Max	P Max
303	Bars	6901-71	X10 Cr Ni S 18 09 ⁽¹⁾	0.12	1.0	2.0	8.0- 11.0	17.0- 19.0	0.6 max	-	-	0.15 0.35	0.20
304	Bars Plates Sheet and strip	6901-71 6902-71 6903-71	} X5 Cr Ni 18 10	0.06	1.0	2.0	8.0- 11.0	17.0- 19.0	-	-	-	0.030	0.045
	Seamless tube	6904-71											
	Bars Sheet and strip	6901-71 6903-71	} X8 Cr Ni 19 10	0.04- 1.0	0.75	2.0	8.0- 12.0	18.0- 20.0	-	-	-	0.030	0.045
	Seamless tube	6904-71											
304L	Bars Plates Sheet and strip	6901-71 6902-71 6903-71	} X2 Cr Ni 18 11	0.03	1.0	2.0	9.0- 12.0	17.0- 19.0	-	-	-	0.030	0.045
	Seamless tube	6904-71											
316	Bars Plates Sheet and strip	6901-71 6902-71 6903-71	} X5 Cr Ni Mo 17 12	0.06	1.0	2.0	10.5- 13.5	16.0- 18.5	2.0- 2.5	-	-	0.030	0.045
	Seamless tube	6904-71											
	Bars Sheet and strip Seamless tube	6901-71 6903-71 6904-71	} X8 Cr Ni Mo 17 12	0.04- 0.10	0.75	2.0	11.0- 13.5	16.0- 18.0	2.0- 2.5	-	-	0.030	0.030
	Bars Plates Sheet and strip	6901-71 6902-71 6903-71											
	Seamless tube	6904-71	X5 Cr Ni Mo 17 13	0.08	0.75	2.0	11.0- 14.0	16.0- 18.0	2.5- 3.0	-	-	0.030	0.030
	Bars Seamless tube	6901-71 6904-71	} X8 Cr Ni Mo 17 13	0.04- 1.0	0.75	2.0	11.0- 14.0	16.0- 18.0	2.5- 3.0	-	-	0.030	0.030
316L	Bars Plates Sheet and strip	6901-71 6902-71 6903-71											
Seamless tube	6904-71	X2 Cr Ni Mo 17 12	0.03	0.75	2.0	11.0- 14.0	16.0- 18.0	2.0- 2.5	-	-	0.030	0.030	
Bars Plates Sheet and strip	6901-71 6902-71 6903-71	} X 2 Cr Ni Mo 17 13	0.03	1.0	2.0	11.5- 14.5	16.0- 18.5	2.5- 3.0	-	-	0.030	0.045	
Seamless tube	6904-71												X2 Cr Ni Mo 17 13
(316Ti)	Bars Plates Sheet and strip	6901-71 6902-71 6903-71	} X6 Cr Ni Mo Ti 17 12	0.08	1.0	2.0	10.5- 13.5	16.0- 18.5	2.0- 2.5	5 × C 0.8 max	-	0.030	0.045
	Seamless tube	6904-71											
	Bars Plates Sheet and strip	6901-71 6902-71 6903-71	} X6 Cr Ni Mo Ti 17 13	0.08	1.0	2.0	11.6- 14.5	16.0- 18.5	2.5- 3.0	5 × C 0.8 max	-	0.030	0.045
	Seamless tube	6904-71											

(1) A minimum content of 0.15% Se may be requested instead of sulphur.

(continued)

Table 5a. Continued.

Nearest AISI steel type	Form of product	UNI speci- fication	Steel designation	Composition. Weight per cent									
				C Max	Si Max	Mn Max	Ni	Cr	Mo	Ti Min	Nb + Ta min	S Max	P Max
(316Nb)	Bars Plates Sheet and strip	6901-71 6902-71 6903-71	X6 Cr Ni Mo Nb 17 12	0.08	1.0	2.0	10.5- 13.5	16.0- 18.5	2.0- 2.5	-	10 × C 1.0 max	0.030	0.045
	Seamless tube	6904-71		0.08	0.75	2.0	10.5- 13.5	16.0- 18.5	2.0- 2.5	-	10 × C 1.0 max	0.030	0.040
	Bars Plates Sheet and strip	6901-71 6902-71 6903-71	X6 Cr Ni Mo Nb 17 13	0.08	1.0	2.0	11.5- 14.5	16.0- 18.5	2.5- 3.0	-	10 × C 1.0 max	0.030	0.045
	Seamless tube	6904-71		0.08	0.75	2.0	11.5- 14.5	16.0- 18.5	2.5- 3.0	-	10 × C 1.0 max	0.030	0.040
321	Bars Plates Sheet and strip	6901-71 6902-71 6903-71	X6 Cr Ni Ti 18 11	0.08	1.0	2.0	9.0- 12.0	17.0- 19.0	-	5 × C 0.8 max	-	0.030	0.045
	Seamless tube	6904-71		0.08	0.75	2.0	9.0- 13.0	17.0- 19.0	-	5 × C 0.6 max	-	0.030	0.030
	Bars Sheet and strip Seamless tube	6901-71 6903-71 6904-71	X8 Cr Ni Ti 18 11	0.04. 0.10	0.75	2.0	9.0- 13.0	17.0- 19.0	-	4 × C 0.6 max	-	0.030	0.030
Seamless tube	6904-71	0.04. 0.10		0.75	2.0	9.0- 13.0	17.0- 19.0	-	4 × C 0.6 max	-	0.030	0.030	
347	Bars Plates Sheet and strip	6901-71 6902-71 6903-71	X6 Cr Ni Nb 18 11	0.08	1.0	2.0	9.0- 12.0	17.0- 19.0	-	-	10 × C 1.0 max	0.030	0.045
	Seamless tube	6904-71		0.08	0.75	2.0	9.0- 13.0	17.0- 19.0	-	-	10 × C 1.0 max	0.030	0.030
	Bars Sheet and strip	6901-71 6903-71	X8 Cr Ni Nb 18 11	0.04. 0.10	0.75	2.0	9.0- 13.0	17.0- 19.0	-	-	10 × C 1.0 max	0.030	0.030
	Seamless tube	6904-71		0.04. 0.10	0.75	2.0	9.0- 13.0	17.0- 19.0	-	-	8 × C 1.0 max	0.030	0.030

Table 5b. Mechanical properties quoted in Italian UNI specifications for the austenitic stainless steels listed in Table 5a.
(Minimum values at room temperature except as stated otherwise)

Nearest AISI steel type	Form of product	UNI specification	Steel designa- tion	Hardness		Proof stress						Tensile strength			Elongation Lo = 5.65 √ So		Impact test (4)	Inter- crystalline corrosion test			
				HB max	HRB max	0.2%			1.0%			N/mm ²	(1) kgf/ mm ²	tonf/ in ²	N/mm ²	(1) kgf/ mm ²			tonf/ in ²	%	
						N/mm ²	(1) kgf/ mm ²	tonf/ in ²	N/mm ²	(1) kgf/ mm ²	tonf/ in ²										
303	Bars	6901-71	X10 Cr Ni S 18 09	-	-	215	22	14	255	26	16.5	490- 735	50- 75	31.5- 47.5	40 ⁽²⁾	35 ⁽³⁾	-	Optional ⁽⁶⁾			
304	Bars	6901-71	X5 Cr Ni 18 10 X8 Cr Ni 19 10	-	-	185	19	12	225	23	14.5	490 685	50- 70	31.5- 44.5	45 ⁽²⁾	40 ⁽³⁾	-	Optional ⁽⁶⁾			
	Plates	6902-71	X5 Cr Ni 18 10	202	94	195	20	12.5	235	24	15	540- 685	55- 70	35- 44.5	45	-					
	Sheet and strip ⁽⁵⁾	6903-71	X5 Cr Ni 18 10	-	88	195	20	12.5	235	24	15	540- 685	55- 70	35- 44.5	45	-					
			X8 Cr Ni 19 10	-	90	205	21	13.5	245	25	16	540- 685	55- 70	35- 44.5	45	-					
	seamless tube	6904-71	X5 Cr Ni 18 10	202	94	195	20	12.5	225	23	14.5	490- 685	50- 70	31.5- 44.5	40	-					
X8 Cr Ni 19 10			202	94	215	22	14	225	23	14.5	490- 685	50- 70	31.5- 44.5	35	-						
304L	Bars	6901-71	X2 Cr Ni 18 11	-	-	175	18	11.5	215	22	14	440- 640	45- 65	28.5- 41.5	45 ⁽²⁾	40 ⁽³⁾	-	Optional ⁽⁶⁾			
	Plates	6902-71		192	90	175	18	11.5	215	22	14	470- 620	48- 63	30.5- 40	45	-					
	Sheet and strip ⁽⁵⁾	6903-71		-	88	175	(1)	11.5	215	(2)	14	520- 665	53- 68	33.5- 43	45	-					
				202	94	195	20	12.5	215	22	14	490- 685	50- 70	31.5- 44.5	40	-					

Table 5b. Continued.

Nearest AISI steel type	Form of product	UNI specification	Steel designation	Hardness		Proof stress						Tensile strength			Elongation Lo = 5.65 √So		Impact test (4)	Inter- crystalline corrosion test		
				HB max	HRB max	0.2%			1.0%			* N/mm ²	(1) kgf/ mm ²	tonf/ in ²	* N/mm ²	(1) kgf/ mm ²			tonf/ in ²	%
						* N/mm ²	(1) kgf/ mm ²	tonf/ in ²	* N/mm ²	(1) kgf/ mm ²	tonf/ in ²									
316	Bars	6901-71	X5 Cr Ni Mo 17 12 X5 Cr Ni Mo 17 13 X8 Cr Ni Mo 17 12 X8 Cr Ni Mo 17 13	-	-	205	21	13.5	245	25	16	490-685	50-70	31.5-44.5	40 ⁽²⁾	35 ⁽³⁾	-	Optional ⁽⁶⁾		
	Plates	6902-71	X5 Cr Ni Mo 17 12 X5 Cr Ni Mo 17 13	217	96	205	21	13.5	245	25	16	540-685	55-70	35-44.5	40	-	-			
	Sheet and strip ⁽⁵⁾	6903-71	X5 Cr Ni Mo 17 12 X5 Cr Ni Mo 17 13 X5 Cr Ni Mo 17 12	-	95	205	21	13.5	245	25	16	540-685	55-70	35-44.5	40	-	-			
	Seamless tube	6904-71 ⁽⁷⁾	X5 Cr Ni Mo 17 12 X5 Cr Ni Mo 17 13 X8 Cr Ni Mo 17 12 X8 Cr Ni Mo 17 13	202	94	215	22	14	245	25	16	490-685	50-70	31.5-44.5	40	-	-			
316L	Bars	6901-71	X2 Cr Ni Mo 17 12 X2 Cr Ni Mo 17 13	-	-	195	20	12.5	235	24	15	440-685	45-70	28.5-44.5	40 ⁽²⁾	35 ⁽³⁾	-	Optional ⁽⁶⁾		
	Plates	6902-71	X2 Cr Ni Mo 17 12 X2 Cr Ni Mo 17 13	217	96	195	20	12.5	235	24	15	490-640	50-65	31.5-41.5	40	-	-			
	Sheet and strip ⁽⁵⁾	6903-7	X2 Cr Ni Mo 17 12 X2 Cr Ni Mo 17 13	-	95	195	20	12.5	235	24	15	520-665	53-68	33.5-43	40	-	-			
	Seamless tube	6904-71 ⁽⁷⁾	X2 Cr Ni Mo 17 12 X2 Cr Ni Mo 17 13	202	94	215	(2)	14	235	(2)	15	490-685	50-70	31.5-44.5	40	-	-			
(316 Ti)	Bars	6901-71	X6 Cr Ni Mo Ti 17 12 X6 Cr Ni Mo Ti 17 13	-	-	225	23	14.5	265	27	17	490-735	50-75	31.5-47.5	35 ⁽²⁾	30 ⁽³⁾	-	Optional ⁽⁶⁾		
	Plates	6902-71	X6 Cr Ni Mo Ti 17 12 X6 Cr Ni Mo Ti 17 13	217	96	215	22	14	255	26	16.5	540-685	55-70	35-44.5	40	-	-			
	Sheet and strip ⁽⁵⁾	6903-71	X6 Cr Ni Mo Ti 17 12 X6 Cr Ni Mo Ti 17 13	-	95	215	22	14	255	26	16.5	540-685	55-70	35-44.5	40	-	-			
	Seamless tube	6904-71 ⁽⁷⁾	X6 Cr Ni Mo Ti 17 12 X6 Cr Ni Mo Ti 17 13	202	94	215	22	14	265	27	17	490-685	50-70	31.5-44.5	40	-	-			
(31614b)	Bars	6901-71	X6 Cr Ni Mo Nb 17 12	-	-	225	23	14.5	265	27	17	490-685	50-70	31.5-44.5	35 ⁽²⁾	30 ⁽³⁾	-	Optional ⁽⁶⁾		
			X6 Cr Ni Mo Nb 17 13	-	-	225	23	14.5	265	27	17	490-735	50-75	31.5-47.5	35 ⁽²⁾	30 ⁽³⁾	-			
	Plates	6902-71	X6 Cr Ni Mo Nb 17 12 X6 Cr Ni Mo Nb 17 13	217	96	215	22	14	255	26	16.5	540-685	55-70	35-44.5	40	-	-			
	Sheet and strip ⁽⁵⁾	6903-71	X6 Cr Ni Mo Nb 17 12 X6 Cr Ni Mo Nb 17 13	-	95	215	22	14	255	26	16.5	540-685	55-70	35-44.5	40	-	-			
	Seamless tube	6904-71 ⁽⁷⁾	X6 Cr Ni Mo Nb 17 12 X6 Cr Ni Mo Nb 17 13	202	94	215	22	14	265	27	17	490-685	50-70	31.5-44.5	35	-	-			
321	Bars	6901-71	X6 Cr Ni Ti 18 11 X8 Cr Ni Ti 18 11	-	-	205	21	13.5	245	25	16	490-735	50-75	31.5-47.5	40 ⁽²⁾	35 ⁽³⁾	-	Optional ⁽⁶⁾		
	Plates	6902-71	X6 Cr Ni Ti 18 11	202	94	205	21	13.5	245	25	16	540-685	55-70	35-44.5	40	-	-			
	Sheet and strip ⁽⁵⁾	6903-71	X6 Cr Ni Ti 18 11	-	88	205	21	13.5	245	25	16	540-685	55-70	35-44.5	40	-	-			
			X8 Cr Ni Ti 18 11	-	90	205	21	13.5	245	25	16	540-685	55-70	35-44.5	40	-	-			
	Seamless tube	6904-71 ⁽⁷⁾	X6 Cr Ni Ti 18 11 X8 Cr Ni Ti 18 11	202	94	215	22	14	245	25	16	490-685	50-70	31.5-44.5	40	-	-			
347	Bars	6901-71	X6 Cr Ni Nb 18 11 X8 Cr Ni Nb 18 11	-	-	205	21	13.5	245	25	16	490-735	50-75	31.5-47.5	40 ⁽²⁾	35 ⁽³⁾	-	Optional ⁽⁶⁾		
	Plates	6902-71	X6 Cr Ni Nb 18 11	202	94	205	21	13.5	245	25	16	540-685	55-70	35-44.5	40	-	-			
	Sheet and strip ⁽⁵⁾	6903-71	X6 Cr Ni Nb 18 11	-	88	205	21	13.5	245	25	16	540-685	55-70	35-44.5	40	-	-			
			X8 Cr Ni Nb 18 11	-	90	205	21	13.5	245	25	16	540-665	55-70	35-44.5	40	-	-			
	Seamless tube	6904-71 ⁽⁷⁾	X6 Cr Ni Nb 18 11 X8 Cr Ni Nb 18 11	202	94	215	22	14	245	25	16	490-685	50-70	31.5-44.5	35	-	-			

Heat treatment condition: X6 Cr Ni Ti 18 11
X8 Cr Ni Ti 18 11
X6 Cr Ni Nb 18 11
X8 Cr Ni Nb 18 11 } Annealed 1000°C-1100°C, rapidly cooled
All other steels—Annealed 1050°C-1100°C, rapidly cooled

*Other values converted from this unit except (1).

(1) Values in this unit are also given in the specification.

(2) ≤40mm diameter.

(3) >40≤100mm diameter.

(4) Impact test values are not specified.

(5) Thickness up to 3mm.

(6) By agreement between purchaser and supplier an intercrystalline corrosion test may be carried out in accordance with procedures specified in UNI 6375-68 (hot copper sulphate solution) or UNI 6376-68 (hot concentrated nitric acid).

(7) A flattening test in accordance with the method described in UNI 5468-65, and a hydraulic pressure test are also specified.

Table 6a. Chemical compositions of wrought austenitic stainless steels suitable for use at low temperatures. Swedish specifications.

Nearest AISI steel type	Swedish specification SIS	Composition for all product forms, except as stated otherwise. Weight per cent.									
		C max	Si max	Mn max	Ni	Cr	Mo	Ti min	Nb + ½ Ta min	S max	P max
304	14 23 33 : 65	0.06	1.0	2.0	8.0–12.0	17.0–20.0	–	–	–	0.030	0.045
304L	14 23 52 : 65	0.03	1.0	2.0	9.0–12.0	17.0–20.0	–	–	–	0.030	0.045
321	14 23 37 : 67	0.08	1.0	2.0	9.0–12.0	17.0–19.0	–	5 × C 0.7 max	–	0.030	0.045
	Bar, tube or forgings				13.0 max						
347	14 23 38 : 65	0.08	1.0	2.0	9.0–12.0	17.0–19.0	–	–	10 × C 1.2 max	0.030	0.045
	Bar, tube or forgings				13.0 max						
316	14 23 47 : 68	0.05	1.0	2.0	10.5–14.0	16.5–19.0	2.0–2.5	–	–	0.030	0.045
316	14 23 43 : 69	0.05	1.0	2.0	10.5–14.0	16.5–19.0	2.5–3.0	–	–	0.030	0.045
316L	14 23 53 : 65	0.03	1.0	2.0	11.5–14.5	16.5–18.5	2.5–3.0	–	–	0.030	0.045
	Tube				15.0 max						
(316 Ti)	14 23 44: 65	0.08	1.0	2.0	10.5–14.0	16.5–19.0	2.5–3.0	5 × C 0.7 max	–	0.030	0.045
	Bar, tube or forgings				15.0 max						

Table 6b. Mechanical properties quoted in Swedish specifications for the austenitic stainless steels listed in Table 6a.
(Minimum values at room temperature except as stated otherwise)

Nearest AISI steel type	304	304L	321	347	316	316	316L	(316 Ti)
Swedish specification	SIS 14 23 33	SIS 14 23 52	SIS 14 23 37	SIS 14 23 38	SIS 14 23 47	SIS 14 23 43	SIS 14 23 53	SIS 14 23 44
Condition: Annealed at °C	1050	1020	1020	1020	1050	1050	1020	1020
0.2% proof stress	(a) (b) (c) (d) (e)	(a) (b)	(a) (b)	(a) (b)	(a) (b)	(e) (b) (c) (d) (e)	(e) (b) (c) (d) (e)	(a) (b)
N/mm ² tonf/in ² *kgf/mm ²	200 180 – – – 13 11 – – – 20 18 – – –	180 170 11 11 18 17	210 190 13 12 21 19	220 200 14 13 22 20	220 200 14 13 22 20	220 200 – – – 14 13 – – – 22 20 – – –	200 180 – – – 13 11 – – – 20 18 – – –	210 13 23 21
Tensile strength	(a) (b) (c) (d) (e)	(a) (b)	(a) (b)	(a) (b)	(a) (b)	(a) (b) (c) (d) (e)	(a) (b) (c) (d) (e)	(a) (b)
N/mm ² tonf/in ² *kgf/mm ²	490 490 max 880 max 780 max 740 32 32 57 51 48 50 50 90 80 75	460 460 30 30 47 47	490 490 32 32 50 50	490 490 32 32 50 50	490 490 32 32 50 50	490 490 max 880 max 780 max 740 32 32 57 51 48 50 50 90 80 75	490 490 max 880 max 780 max 740 32 32 57 51 48 50 50 90 80 75	490 490 32 32 50 50
Elongation % on 5.65√So	45 45 – – –	45 45	40 40	40 40	45 45	45 45 – – –	45 45 – – –	40 40
Hardness HB max	180 180 – – –	180 180	190 190	190 190	180 180	180 180 – – –	180 180 – – –	190 190
Impact strength	Not specified							
Mandatory inter-crystalline corrosion test	Yes (f)	Yes (g)	Yes (g)	Yes (g)	Yes (h)	Yes (h)	Yes (i)	Yes (i)

*Other values converted from this unit.

(a) Plate ≤30mm thick, bar and forgings ≤50mm thick, seamless and welded tube ≤15mm wall thickness.

(b) Plate 30–50mm thick, bar and forgings 50–100mm thick, seamless and welded tube >15mm wall thickness.

(c) Sheet <1mm thick.

(d) Sheet 1–3mm thick.

(e) Sheet >3mm thick.

(f) After sensitizing 5 min at 680°C.

(g) After sensitizing 30 min at 680°C.

(h) After sensitizing 8 min at 740°C.

(i) After sensitizing 30 min at 740°C.

Table 7. Chemical compositions of cast austenitic steels suitable for use at low temperatures. British, Swedish, American and German specifications.

Nearest AISI steel type	Specification	Composition. Weight per cent.									
		C max	Si max	Mn max	Ni	Cr	Mo	Nb min	S max	P max	
	British										
	BS1631 : 67				min						
304	Grade A	0.08	1.5	2.0	8.0	17.0–21.0	–	–	0.040	0.040	
304L	Grade C	0.03	1.5	2.0	8.0	17.0–21.0	–	–	0.040	0.040	
347	Grade B	0.06	1.5	2.0	8.5	17.0–21.0	–	8 × C ⁽¹⁾ 0.9 max	0.040	0.040	

(1) Ti in the proportion 5 × %C min and 0.7% max may be substituted for Nb by agreement between manufacturer and purchaser.

(Continued)

Table 7. Continued.

Nearest AISI steel type	Specification		Composition. Weight per cent.									
			C max	Si max	Mn max	Ni	Cr	Mo	Nb min	S max	P max	
	BS1632 : 67					min						
316		Grade A	0.08	1.5	2.0	10.0	17.0– 20.0	2.0– 3.0	–	0.040	0.040	
316		Grade D	0.08	1.5	2.0	8.0	17.0– 20.0	2.0– 3.0	–	0.040	0.040	
316		Grade E	0.08	1.5	2.0	8.0	17.0– 20.0	1.75– 2.0	–	0.040	0.040	
316L		Grade F	0.03	1.5	2.0	10.0	17.0– 20.0	2.0– 3.0	–	0.040	0.040	
	Swedish											
304	SIS14 23 33 : 69	Steel 23 33-12	0.06	1.5	2.0	8.0– 11.0	17.5– 20.5	–	–	0.035	0.045	
316	SIS14 23 43 : 69	Steel 23 43-12	0.06	1.5	2.0	10.0– 13.5	17.0– 20.0	2.5– 3.2	–	0.035	0.045	
	American											
	ASTM A296: 68 and ASME SA-351 :68											
304		Grade CF-8	0.08	2.0	1.5	8.0– 11.0	18.0– 21.0	–	–	0.040	0.040	
304L		CF-3	0.03	2.0	1.5	8.0– 12.0	17.0– 21.0	–	–	0.040	0.040	
316		CF-8M	0.08	2.0	1.5	9.0– 12.0	18.0– 21.0	2.0– 3.0	–	0.040	0.040	
316L		CF-3M	0.03	1.5	1.5	9.0– 13.0	17.0– 21.0	2.0– 3.0	–	0.040	0.040	
347		CF-8C	0.08	2.0	1.5	9.0– 12.0	18.0– 21.0	–	8 × C 1.0 max	0.040	0.040	
	German											
	SEW685–68											
	Steel designation	Werkstoff Nr.						max				
304	G– X6 Cr Ni 18 10	1.6902	0.07	2.0	2.0	9.0– 11.0	17.5– 20.0	0.7	–	0.030	0.045	
347	G– X7 Cr Ni Nb 18 10	1.6905	0.07	1.5	2.0	9.0– 11.0	17.5– 20.0	0.7	8 × C	0.030	0.045	
	DIN 17445–69											
	Steel designation	Werkstoff Nr.										
304	G– X6 Cr Ni 18 19	1.4308	0.07	2.0	1.5	9.0– 11.0	17.5– 20.0	–(2)	–	0.030	0.045	
302	G– X10 Cr Ni 18 8	1.4312	0.12	2.0	1.5	8.0– 10.0	17.0– 19.5	–(2)	–	0.030	0.045	
347	G– X7 Cr Ni Nb 18 9	1.4552	0.08	1.5	1.5	9.0– 11.0	17.5– 20.0	–(2)	8 × C	0.030	0.045	

(2) In special cases a maximum Mo content can be agreed upon.

Table 8. Mechanical properties quoted in British Standards for the cast austenitic stainless steels listed in Table 7.

(Minimum values at room temperature except where stated otherwise)

Nearest AISI steel type	304	304L	316	316	316	316L	347
Nearest ASTM cast steel type	CF-8	CF-3	CF-8M	CF-8M	CF-8M	CF-3M	CF-8C
BS1631 : 67 BS1632 : 67	Grade A —	Grade C —	— Grade B	— Grade D	— Grade E	— Grade F	Grade B —
Condition: Annealed °C: WQ or AC	1000– 1100	1000– 1100	1000– 1150	1000– 1150	1000– 1150	1000– 1150	1000– 1150
0.5% proof stress N/mm ² *tonf/in ² **kgf/mm ²	210 13.5 21	190 12 19	210 13.5 21.5	230 15 23.5	210 13.5 21.5	190 12 19	210 13.5 21.5
Tensile strength N/mm ² *tonf/in ² **kgf/mm ²	480 31 49	430 28 44	480 31 49	510 33 52	480 31 49	430 28 44	480 31 49
Elongation %. Lo = 5.65 √So	26	26	26	26	26	26	22
Charpy V-notch impact value at –196°C J daJ/cm ² kgf m **kgf m/cm ² *ft lbf	41 5.1 4.1 5.1 30	41 5.1 4.1 5.1 30	34 4.2 3.5 4.3 25	34 4.2 3.5 4.3 25	34 4.2 3.5 4.3 25	41 5.1 4.1 5.1 30	20 2.5 2.1 2.6 15
Intercrystalline corrosion test	Mandatory ⁽¹⁾	Optional ⁽²⁾	Optional ⁽²⁾	Optional ⁽²⁾	Optional ⁽²⁾	Optional ⁽²⁾	Optional ⁽²⁾

*Other values converted from this unit.

**Values in this unit are also included in the specification.

(1) Without prior sensitizing treatment.

(2) After sensitizing 30 minutes at 650°C.

Table 9. Mechanical properties quoted in Swedish specifications for the cast austenitic stainless steels listed in Table 7.

(Minimum values at room temperature except as stated otherwise)

Nearest AISI steel type	304	316
Nearest ASTM cast steel type	CF-8	CF-8M
SIS specification Steel grade	14 23 33 23 33-12	14 23 43 23 43-12
Condition Annealed at °C	1050	1050
Yield stress N/mm ² tonf/in ² *kgf/mm ²	180 11.5 18	200 12.5 20
Tensile strength N/mm ² tonf/in ² *kgf/mm ²	440 29 45	440 29 45
Elongation on 5.65√So	35	35
Hardness HB	180 max	180 max
Mandatory inter-crystalline corrosion test	No	No

*Other values converted from this unit.

Table 10. Mechanical properties quoted in American specifications ASTM A296-68 and ASME 351-68 for the cast austenitic stainless steels listed in Table 7.

(Minimum values at room temperature)

Nearest AISI steel type	304	304L	316	316L	347
ASTM A296-68 and ASME 351-68 cast steel type	CF-8	CF-3	CF-8M	CF-3M	CF-8C
Condition: Annealed at °C min WQ or rapid cool by other means	1040	1040	1040	1040	1040
Yield stress ⁽¹⁾ N/mm ² tonf/in ² kgf/mm ² *10 ³ lbf/in ²	190 (210) 12.5 (13.5) 20 (21) 28 (30)	190 (210) 12.5 (13.5) 20 (21) 28 (30)	210 13.5 21 30	210 13.5 21 30	210 13.5 21 30
Tensile strength ⁽¹⁾ N/mm ² tonf/in ² kgf/mm ² *10 ³ lbf/in ²	450 (480) 29.0 (31.0) 46 (49) 65 (70)	450 (480) 29.0 (31.0) 46 (49) 65 (70)	480 31.0 49 70	480 31.0 49 70	480 31.0 49 70
Elongation % on 4D	35	35	30	30	30
Mandatory intercrystalline corrosion test Or may be requested by purchaser for condition specified	No Yes As-supplied	No Yes Sensitized	No Yes As-supplied	No Yes Sensitized	No Yes Sensitized

*Other values converted from this unit.

(1) Values in parentheses are for ASME-351; where only one value is shown this applies to both ASTM-A296 and ASME-351.

Table 11. Mechanical properties specified in German standards for the cast steels listed in Table 7 in section thicknesses ≤100 mm.

(Minimum guaranteed values at room temperature except where stated otherwise)

Nearest AISI steel type	304	347	304	302	347
Nearest ASTM cast steel type	CF-8	CF-8C	CF-8		CF-8C
Specification	SEW685-68		DIN 17445-69		
Steel designation	G- X6 Cr Ni 18 10	G- X7 Cr Ni Nb 18 10	G- X6 Cr Ni 18 9	G- X10 Cr Ni 18 8	G- X7 Cr Ni Nb 18 9
Accepted by AD Merkblatt W10 for use down to at least:	-253°C	-196°C	-196°C	-150°C	-100°C
Condition: Annealed at °C WQ or OQ	1050	1050	1050- 1100 ⁽¹⁾	1050- 1100 ⁽¹⁾	1050- 1100 ⁽¹⁾
0.2% proof stress N/mm ² tonf/in ² *kgf/mm ²	180 11.5 18	180 11.5 18	180 11.5 18	180 11.5 18	180 11.5 18
1.0% proof stress N/mm ² tonf/in ² *kgf/mm ²	200 13 20	200 13 20	200 13 20	200 13 20	200 13 20
Tensile strength N/mm ² tonf/in ² *kgf/mm ²	440-640 29-41 45-65	440-640 29-41 45-65	440-640 29-41 45-65	440-640 29-41 45-65	440-640 29-41 45-65
Elongation %, Lo = 5.65√So	20	20	20	20	20
Reduction of area ≤30mm thick >30 ≤ 100mm thick	45 40	40 35	- -	- -	- -
Impact strength: Type of test-piece Test temperature °C	DVM		DVM		DVM
J	+20 -196	+20 -196	+20	+20	+20
daJ/cm ²	80 50	55 25	69	55	41
kgf m	12 7	8 4	10	8	6
*kgf m/cm ²	8.5 5	5.5 3	7	5.5	4
ft lbf	12 7	8 4	10	8	6
	60 35	40 20	51	41	30

*Other values converted from this unit.

(1) May also be air cooled.

Table 12. High proof stress (nitrogen strengthened) stainless steels. Chemical compositions of steels produced in various countries.

Nearest AISI steel type	Specification and steel designation	Form	Composition. Weight per cent									
			C max	Si	Mn	Ni	Cr	Mo	N ₂	Nb min	S max	P max
	United Kingdom BS1501 : Part 3 : 1973											
(304N)	304S65	Plates ≤1¼ in (32mm) thick. (Other forms are also available from manufacturers)	0.06	0.2– 1.0	0.5– 2.0	8.0– 11.0	17.5– 19.0	–	0.15– 0.25	–	0.030	0.045
(304LN)	304S62		0.03	0.2– 1.0	0.5– 2.0	9.0– 12.0	17.5– 19.0	–	0.15– 0.25	–	0.030	0.045
(316N)	316S66		0.07	0.2– 1.0	0.5– 2.0	10.0– 13.0	16.5– 18.5	2.25– 3.0	0.15– 0.25	–	0.030	0.045
(316LN)	316S62		0.03	0.2– 1.0	0.5– 2.0	11.0– 14.0	16.5– 18.5	2.25– 3.0	0.15– 0.25	–	0.030	0.045
(347N)	347S67		0.08	0.2– 1.0	0.5– 2.0	9.0– 12.0	17.0– 19.0	–	0.15– 0.25	10 × C 1.0 max	0.030	0.045
	France AFNOR A35–582 : 72			max	max							
(304LN)	Z2CN 18–10 + N ₂		0.03	1.0	2.0	9.0– 11.5	17.0– 19.0	–	0.10– 0.12	–	–	–
(316LN)	Z2CND 17–12 + N ₂		0.03	1.0	2.0	10.5– 13.5	16.5– 18.5	2.0– 2.5	0.12– 0.20	–	–	–
(316LN)	Z2CND 17–13 + N ₂		0.03	1.0	2.0	12.0– 14.5	16.5– 18.5	2.5– 3.0	0.12– 0.20	–	–	–
	Germany DIN 17440 : 1972											
(304LN)	X2 Cr Ni N 18 10 Werkstoff Nr. 1.4311	Plates, Sheet, Bars, Sections and Forgings	0.03	1.0	2.0	9.0– 11.5	17.0– 19.0	–	0.12 ⁽¹⁾ –0.2	–	–	–
(316LN)	X2 Cr Ni Mo N 18 12 Werkstoff Nr. 1.4406		0.03	1.0	2.0	10.5– 13.5	16.5– 18.5	2.0– 2.5	0.12 ⁽¹⁾ –0.2	–	–	–
(316LN)	X2 Cr Ni Mo N 18 13 Werkstoff Nr. 1.4429		0.03	1.0	2.0	12.0– 14.5	16.5– 18.5	2.5– 3.0	0.14 ⁽¹⁾ –0.22	–	–	–
	Italy											
(304N)	–	Plates and Sheet ≥1mm	0.06	1.0	2.0	8.0– 11.0	18.0– 20.0	–	0.15– 0.25	–	–	–
(304LN)	–		0.03	1.0	2.0	9.0– 12.0	18.0– 20.0	–	0.15– 0.25	–	–	–
(316LN)	–		0.03	1.0	2.0	11.0– 14.5	16.0– 18.0	2.0– 3.0	0.15– 0.25	–	–	–
	Sweden											
(304LN)	SIS14–2371	Plates, Sheet, Bars and Forgings	0.03	1.0	2.0	9.0– 12.0	17.0– 20.0	–	0.15– 0.25	–	–	–
(316LN)	SIS14 2375		0.03	1.0	2.0	11.0– 14.0	16.5– 18.5	2.5– 3.0	0.15– 0.25	–	–	–

(1) The minimum nitrogen content may be reduced by 0.02% providing the specified mechanical properties are obtained.

Table 13. High proof stress stainless steels. Mechanical properties quoted in British Standard BS1501: Part 3: 1973.

(Minimum values at room temperature)

Nearest AISI steel type	(304N)		I (304LN)		(316N)		(316LN)		(347N)	
BS 1501 : Part 3 : 1973 Steel designation	304565		304562		316566		316562		347567	
Annealed at °C, AC, OQ, or WQ	1000–1120		1000–1120							
0.2% Proof stress N/mm ² *tonf/in ² kgf/mm ²	295 19.0 30.0		295 19.0 30.0		315 20.5 32.0		315 20.5 32.0		340 22.0 35.0	
1.0% Proof stress N/mm ² *tonf/in ² kgf/mm ²	315 20.5 32.5		315 20.5 32.5		340 22.0 35.0		340 22.0 35.0		370 24.0 38.0	
Tensile strength N/mm ² *tonf/in ² kgf/mm ²	590 38.0 60.0		590 38.0 60.0		620 40 63.0		620 40 63.0		650 42.0 66.0	
Elongation Lo = 2 in (51 mm) Lo = 5.65 √So	35 35		35 35		35 35		35 35		35 35	
Intercrystalline corrosion test	Optional ⁽¹⁾		Optional ⁽¹⁾		Optional ⁽¹⁾		Optional ⁽²⁾		Optional ⁽²⁾	
Impact strength	An impact test is not specified. The data below are minimum values to be expected from proprietary steels conforming to the BS1501 : Part 3 : 1971 requirements.									
Temperature of test °C	20	–196	20	–196	20	–196	20	–196	20	–196
Charpy V-notch J daJ/cm ² kgf m kgf m/cm ² *ft IV	61 12 6.2 8 45	27 5.4 3 4 20	61 12 6.2 8 45	27 5.4 3 4 20	54 11 5.5 7 40	27 5.4 3 4 20	54 11 5.5 7 40	27 5.4 3 4 20	27 5.4 3 4 20	– – – – –
DVM J daJ/cm ² kgf m kgf m/cm ² *ft lbf	89 13 9 13 66	41 6 4 6 30	89 13 9 13 66	41 6 4 6 30	69 10 7 10 51	41 6 4 6 30	69 10 7 10 51	41 6 4 6 30	47 7 5 7 35	– – – – –

*Other values converted from this unit.

(1) If an intercrystalline corrosion test is required the test-piece shall be sensitized 15 minutes at 650°C.

(2) The test-piece shall be sensitized 30 minutes at 650°C.

Table 14. High proof stress stainless steels. Mechanical properties quoted in French specification AFNOR A35-582 : 1972.
(Minimum values at room temperature except as stated otherwise)

Nearest AISI steel type		(304LN)				(316LN)				(376LN)							
AFNOR A35-582 : 72 Steel designation		Z2CN18-10+N ₂				Z2CND17-12+ N ₂				Z2CN017-13+N ₂							
		Bars and Forgings		Plate	Bars and Forgings		Plate	Bars and Forgings		Plate							
		<25mm	25-100mm	<20mm thick	<25mm	25-100mm	<20mm thick	<25mm	25-100mm	<20mm thick							
Annealed at °C WQ or AC		1000-1100				1000-1100				1000-1100							
0.2% Proof stress *N/mm ² tonf/in ² kgf/mm ²		270 17.5 28	240 15.5 24	270 17.5 28	280 18 29	270 17.5 28	300 19.5 31	280 18 29	270 17.5 28	300 19.5 31							
Tensile strength *N/mm ² tonf/in ² kgf/mm ²		550 36 56	550 36 56	550 36 56	600 39 61	600 39 61	600 39 61	600 39 61	600 39 61	600 39 61							
Elongation % on 5.65 $\sqrt{S_0}$		45 ⁽¹⁾	42 ⁽²⁾	40 ⁽³⁾ 45 ⁽⁴⁾ 43 ⁽⁵⁾	45 ⁽¹⁾	42 ⁽²⁾	40 ⁽³⁾ 45 ⁽⁴⁾ 43 ⁽⁵⁾	45 ⁽¹⁾	42 ⁽²⁾	40 ⁽³⁾ 45 ⁽⁴⁾ 43 ⁽⁵⁾							
Impact strength ⁽⁶⁾	Test-piece																
Temperature of test °C		+20	-196	+20	-196	+20	-196	+20	-196	+20	-196	+20	-196	+20	-196	+20	-196
Longitudinal J	Charpy V-notch ⁽⁶⁾	-	72 (56)	-	72(56)	-	72(56)	-	72 (56)	-	72 (56)	-	72 (56)	-	72(56)	-	72 (56)
J	Charpy U-notch	60	-	60 ⁽¹⁾ 50 ⁽²⁾	-	60	-	60	-	60 ⁽¹⁾ 50 ⁽²⁾	-	60	-	60	-	60	-
*daJ/cm ²	Charpy V-notch ⁽⁶⁾	-	9 (7)	-	9 (7)	-	9 (7)	-	9 (7)	-	9 (7)	-	9 (7)	-	9 (7)	-	9(7)
*daJ/cm ²	Charpy U-notch	12	-	12 ⁽¹⁾ 10 ⁽²⁾	-	12	-	12	-	12 ⁽¹⁾ 10 ⁽²⁾	-	12	-	12	-	12	-
kgf m	Charpy V-notch ⁽⁶⁾	-	7.5(5.5)	-	7.5(5.5)	-	7.5(5.5)	-	7.5(5.5)	-	7.5(5.5)	-	7.5(5.5)	-	7.5(5.5)	-	7.5(5.5)
kgf m	Charpy U-notch	6	-	6 ⁽¹⁾ 5 ⁽²⁾	-	6	-	6	-	6 ⁽¹⁾ 5 ⁽²⁾	-	6	-	6	-	6	-
kgf m/cm ²	Charpy V-notch ⁽⁶⁾	-	9(7)	-	9 (7)	-	9(7)	-	9 (7)	-	9 (7)	-	9 (7)	-	9(7)	-	9(7)
kgf m/cm ²	Charpy U-notch	12	-	12 ⁽¹⁾ 10 ⁽²⁾	-	12	-	12	-	12 ⁽¹⁾ 10 ⁽²⁾	-	12	-	12	-	12	-
ft lbf	Charpy V-notch ⁽⁶⁾	-	53 (41)	-	53 (41)	-	53 (41)	-	53 (41)	-	53 (41)	-	53 (41)	-	53 (41)	-	53(41)
ft lbf	Charpy U-notch	44	-	44 ⁽¹⁾ 37 ⁽²⁾	-	44	-	44	-	44 ⁽¹⁾ 37 ⁽²⁾	-	44	-	44	-	44	-
Mandatory inter-crystalline corrosion test		No	No	No	No	No	No	No	No	No	No	No	No	No	No	No	No

* Other values converted from this unit.

(1) d≤50mm.

(2) 50-100mm diameter or thickness.

(3) < 3mm thick.

(4) 3-10mm thick.

(5) 10-20mm thick.

(6) Values in parentheses are minimum individual test values.

Table 15. High proof stress stainless steels. Mechanical properties quoted in German specification DIN 17740 : 1972 for plate, sheet, bar, sections and forgings.

Accepted by AD Merkblatt W10 as suitable for pressure vessels at temperatures down to at least -253°C .

(Minimum values at room temperature except where stated otherwise)

Nearest AISI steel type	(304LN)		(316LN)		(316LN)	
DIN 17740-72 Steel designation and Werkstoff number	X2 Cr Ni N 18 10 1.4311		X2 Cr Ni Mo N 18 12 1.4406		X2 Cr Ni Mo N 18 13 1.4429	
Condition:	Annealed and quenched		Annealed and quenched		Annealed and quenched	
Hardness HB	140-200		150-210		150-210	
0.2% proof stress *N/mm ² tonf/in ² kgf/mm ²	270 17.5 28		280 18 29		300 19.5 31	
1.0% proof stress *N/mm ² tonf/in ² kgf/mm ²	310 20 32		320 20.5 33		340 22 35	
Tensile strength *N/mm ² tonf/in ² kgf/mm ²	550-750 36-49 56-76		600-800 39-52 61-82		600-800 39-52 61-82	
	Long	Transv	Long	Transv	Long	Transv
Elongation % on 5.65√So ≤10mm thick, or ≤60mm diameter > 10 ≤50mm thick, or > 60 ≤160mmdiameter	40 35	30 26	40 35	30 26	40 35	30 26
Impact strength DVM *J daJ/cm ² kgf m kgf m/cm ² ft lbf	85 12.1 8.7 12.4 63	55 7.9 5.6 80 41	85 12.1 8.7 12.4 63	55 7.9 5.6 8.0 41	85 12.1 8.7 12.4 63	55 7.9 5.6 8.0 41
Resistance to inter- crystalline corrosion	Required to be guaranteed in the as-supplied condition or as-welded.					

*Other values converted from this unit.

Table 16. High proof stress stainless steels. Mechanical properties of plates and sheet of Italian-produced steels having compositions conforming with the ranges given in Table 12.

(For room-temperature tests except where stated otherwise)

Nearest AISI steel type		(304N)		(304LN)		(316LN)	
Local standard		-		-		-	
Condition: Annealed at °C		1000		1000		1000	
0.2% proof stress min N/mm ² tonf/in ² *kgf/mm ²		290-310 19-20.5 30-32		280-290 18.5-19 29-30		290 19 30	
1.0% proof stress min N/mm ² tonf/in ² *kgf/mm ²		320-340 21-22 33-35		310-320 20.5-21 32-33		320-330 21-21.5 33-34	
Tensile strength N/mm ² tonf/in ² *kgf/mm ²		540-740 35-48 55-75		540-740 35-48 55-75		540-780 35-71 55-80	
Elongation %, min on 50mm		40-45		40-45		35-45	
Impact strength, min	Test-piece						
Temperature of test °C		+20	-196	+20	-196	x-20 l	-196
J	Charpy V-notch	-	63	-	63	-	-
J	Charpy U-notch	59	-	59	-	59	-
J	DVM	103 76 (T)	76	103 76 (T)	76	103 76 (T)	-
daJ/cm ²	Charpy V-notch	-	8	-	8	-	-
daJ/cm ²	Charpy U-notch	12	-	12	-	12	-
daJ/cm ²	DVM	15 11 (T)	11	15 11 (T)	11	15 11 (T)	-
kgf m	Charpy V-notch	-	6.5	-	6.5	-	-
kgf m	Charpy U-notch	6	-	6	-	6	-
kgf m	DVM	10.5 7.5 (T)	7.5	10.5 7.5 (T)	7.5	10.5 7.5 (T)	-
*kgf m/cm ²	Charpy V-notch	-	8	-	8	-	-
*kgf m/cm ²	Charpy U-notch	12	-	12	-	12	-
*kgf m/cm ²	DVM	15 11 (T)	11	15 11 (T)	11	15 11 (T)	-
ft lbf	Charpy V-notch	-	46	-	46	-	-
ft lbf	Charpy U-notch	43	-	43	-	43	-
ft lbf	DVM	76 56 (T)	56	76 56 (T)	56	76 56 (T)	-

*Other values converted from this unit.

(T) - Transverse. All other impact values shown are for longitudinal specimens.

Table 17. High proof stress stainless steels. Mechanical properties quoted in Swedish specifications.

(Minimum values at room temperature except where stated otherwise)

Nearest AISI steel type	(304LN)				(316LN)			
Swedish specification	SIS14-2371				SIS14-2375			
	Plate and sheet ≤30mm Bars and forgings ≤50mm Tube ≤15mm	Plate 30-50mm Bars and forgings 50-100mm Tube >15mm	Plate 30-50mm Bars and forgings 50-100mm Tube >15mm	Plate and sheet ≤30mm Bars and forgings ≤50mm Tube ≤15mm	Plate 30-50mm Bars and forgings 50-100mm Tube >15mm	Plate 30-50mm Bars and forgings 50-100mm Tube >15mm	Plate 30-50mm Bars and forgings 50-100mm Tube >15mm	Plate 30-50mm Bars and forgings 50-100mm Tube >15mm
Annealed at °C	1050	1050	1050	1050	1050	1050	1050	1050
0.2% proof stress min N/mm ² tonf/in ² *kgf/mm ²	270 18 28	250 16.5 26	250 16.5 26	290 19 30	290 19 30	290 19 30	270 18 28	270 18 28
1.0% proof stress min N/mm ² tonf/in ² *kgf/mm ²	310 ⁽³⁾ 20.5 ⁽³⁾ 32 ⁽³⁾ (plate and bars)	310 ⁽³⁾ 20.5 ⁽³⁾ 32 ⁽³⁾ (bars)	310 ⁽³⁾ 20.5 ⁽³⁾ 32 ⁽³⁾ (bars)	- - -	- - -	- - -	- - -	- - -
Tensile strength N/mm ² tonf/in ² *kgf/mm ²	540-740 35-48 55-75	540-740 35-48 55-75	540-740 35-48 55-75	590-780 38-51 60-80	590-780 38-51 60-80	590-780 38-51 60-80	590-780 38-51 60-80	590-780 38-51 60-80
Elongation % on 5.65√So	40	40	40	40	40	40	40	40
Hardness HB max	200	200	200	200	200	200	200	200
Charpy V-notch ⁽¹⁾ Impact value			Bars				Bars	
	+20	-196	+20	-196	+20	-196	+20	-196
Temperature °C	(2)	min	(2)	min	(2)	min	(2)	min
J	ca 170	55	ca 170	55	ca 240	55	ca 240	55
daJ/cm ²	ca 22	7	ca 22	7	ca 29	7	ca 29	7
kgf m	ca 18	5.5	ca 18	5.5	ca 24	5.5	ca 24	5.5
*kgf m/cm ²	ca 22	7	ca 22	7	ca 30	7	ca 30	7
ft lbf	ca 130	41	ca 130	41	ca 175	41	ca 175	41

* Other values converted from this unit.

(1) Impact strength not specified. Data given are for proprietary steels.

(2) Typical value.

(3) Data for proprietary steel.

Table 18. Design stresses allowed in various codes and specifications for austenitic stainless steels used for cryogenic pressure vessels.

Specification or Code	Maximum design stress factors			Other stipulations								
	Tensile	Shear	Bearing stress									
British Standard 1515 Part 2: 1968	2/3rds of the specified minimum yield stress (or 1% proof stress) at room temperature.* 2/5ths of the specified minimum tensile strength at room temperature* (this factor is not normally effective and is included to provide for the possibility of using high proof stress stainless steels. It is subject to review according to future experience).	If material is subjected to shear alone, 50% of the maximum tensile design stress is allowed.	Nominal bearing stress shall not exceed 1-5 times the maximum tensile design stress.	<p>Elongation in the tensile test on a gauge length of 5-65/So shall be not less than: 16% for plates 15% for castings 14% for tubes, pipes and forgings</p> <p>Weld-joint efficiency factors for design purposes:</p> <table> <tr> <td>100% radiographed</td> <td>1.00</td> </tr> <tr> <td>Spot radiographed (at least 10% of length of main seams)</td> <td>0.85</td> </tr> <tr> <td>Not radiographed</td> <td>0.75</td> </tr> </table>	100% radiographed	1.00	Spot radiographed (at least 10% of length of main seams)	0.85	Not radiographed	0.75		
	100% radiographed	1.00										
Spot radiographed (at least 10% of length of main seams)	0.85											
Not radiographed	0.75											
<p>In the case of castings the above factors shall be reduced by a quality factor of 0.75, except that they shall be reduced by a quality factor of 0.90 for the following conditions: (1) Each casting is to be examined radiographically and found free of harmful defects at critical sections, or if machined to expose the full thickness of critical sections (e.g., tube plates containing holes through the thickness). (2) Critical locations are examined for defects by penetrant fluid, or grinding or machining and etching. (3) Rejected castings that are repaired and subsequently heat treated to the satisfaction of the inspecting authority shall have repaired areas re-examined according to (1) and shall be shown free of harmful defects. (4) Satisfactory castings which are assigned a quality factor of 0.90 shall carry a suitable permanent identification mark.</p>												
ASME Boiler and Pressure Vessel Code, 1971, Section VIII, Division 1: Pressure Vessels	<p>1/4th of the specified minimum tensile strength at room temperature.</p> <p>For welded pipe and tubes: $\frac{85\% \text{ of min tensile strength}}{4}$</p> <p>For bolting: 1/5th of specified minimum tensile strength.</p> <p>For bars of 304L and 316L grades a max. stress of 15,600 lbf/in² (108 N/mm²) (i.e., < 1/4th × tensile strength) is allowed.</p> <p>For castings: $\frac{80\% \text{ of min tensile strength}}{4}$</p>	For pure shear, 80% of the max tensile design stress is allowed.	1.6 times the max tensile design stress.	<p>Impact tests at service temperatures are not required except as follows: (a) For temperatures below -254°C for Types 304, 304L and 347 steels, and below -198°C for all other grades. (b) For the following materials operating below -29°C, except when the minimum design thickness satisfies certain conditions (for details see paragraph UHA-51 of ASME Code, Section VIII, Division 1): (1) Austenitic Cr-Ni steels with carbon in excess of 0.1%. (2) Austenitic Cr-Ni steels having Cr or Ni content in excess of the specified analysis ranges. (3) Cast steels. (4) Deposited weld metals. (c) Type 316 materials, including stabilized grades, that are stress relieved at temperatures below 900°C. Tests shall include weld metal and be made at the temperature of use.</p> <p>Weld-joint efficiency factors for design purposes:</p> <table> <tr> <td>Double-welded butt joints.</td> <td></td> </tr> <tr> <td>100% radiographed</td> <td>1.00</td> </tr> <tr> <td>Spot radiographed</td> <td>0.85</td> </tr> <tr> <td>Not radiographed</td> <td>0.70</td> </tr> </table> <p>Smaller factors are allowed for other types of joint – see paragraph UW-12 of ASME Code Section VIII.</p>	Double-welded butt joints.		100% radiographed	1.00	Spot radiographed	0.85	Not radiographed	0.70
Double-welded butt joints.												
100% radiographed	1.00											
Spot radiographed	0.85											
Not radiographed	0.70											

Table 18. Continued.

Specification or Code	Maximum design stress factors			Other stipulations
	Tensile	Shear	Bearing stress	
ASME Boiler and Pressure Vessel Code, 1971, Section VIII, Division 2: Alternative Rules for Pressure Vessels	<p>1/3rd of the specified minimum tensile strength at room temperature or 2/3rds of the specified minimum yield strength whichever is the least.</p> <p>For welded pipes and tubes: 85% of the above values.</p> <p>For bolts in tension used in flange connections: 1/5th of specified minimum tensile strength or 1/4th of specified minimum yield strength, whichever is the least.</p>			<p>Impact tests are not required if the design stress does not exceed 6,000 lbf/in² (41.4 N/mm²). For higher design stresses Charpy V-notch impact tests are only required for the materials and conditions given below. For these tests a lateral expansion opposite the notch of not less than 0.015 inch (0.38mm) shall be obtained. The absorbed energy value and per cent shear in the fracture surface shall also be recorded for information only:</p> <p>(a) Types 304, 304L and 347 operating below -254°C, and all other grades below -198°C. (b) For the following materials operating below -29°C: (1) Austenitic Cr-Ni steels with carbon in excess of 0.1%. (2) Austenitic Cr-Ni steels having Cr or Ni content in excess of the specified analysis range. (3) Cast steels.</p> <p>(c) Type 316, including the stabilized grade, at all operating temperatures, when post weld heat treated below 900°C. Tests shall be made on base metal, heat-affected zone material and weld metal at room temperature, or operating temperature if lower.</p>

Table 19. German pressure vessel code AD Merkblatt W10, April 1972. Lowest operating temperatures in relation to design stresses for austenitic stainless steels.

Specification and steel designation		Lowest temperature of application for:			Maximum permissible cold deformation without post-forming heat-treatment	Acceptance test certificate (B or C) in accordance with DIN 50049 and the regulations of the AD Merkblatts indicated
		Type I stress*	Type II stress*	Type III stress*		
DIN 17440 : 72	X5 Cr Ni 18 9 X5 Cr Ni 18 11 X2 Cr Ni 18 9 X10 Cr Ni Ti 18 9 X10 Cr Ni Nb 18 9	-196°C	-253°C	-271°C	10%	B or C in accordance with AD Merkblatt W2 (B for Type I stress, C for Types II and III stress)
	X5 Cr Ni Mo 18 10 X2 Cr Ni Mo 18 10 X10 Cr Ni Mo Ti 18 10 X10 Cr Ni Mo Nb 18 10	-60°C	-110°C	-162°C	10%	
	X2 Cr Ni N 18 10 X2 Cr Ni Mo N 18 12 X2 Cr Ni Mo N 18 13	-253°C	-271 °C	-	10%	C
DIN 267 Blatt 11 : 68 (fasteners)	A2 A4	-196°C -60°C	-	-	-	C
SEW 680 : 70	X12 Cr Ni 19 9 X5 Cr Ni 18 10 X10 Cr Ni Ti 18 10 X10 Cr Ni Nb 18 10	-253°C	-271 °C	-	10%	B or C in accordance with AD Merkblatt W2
DIN 17445 : 69 (castings)	G-X6 Cr Ni 18 9 G-X10 Cr Ni 18 8 G-X7 Cr Ni Nb 18 9	-196°C -150°C -100°C	-253°C -200°C -150°C	-271°C -253°C -200°C	- - -	C
SEW 685 : 68 (castings)	G-X6 Cr Ni 18 10 G-X7 Cr Ni Nb 18 10	-253°C -196°C	-271°C -253°C	- -271 °C	- -	C

*Type I stress: Safety factors given in AD Merkblatt BO are fully utilized. Safety factor correction $S_r = S$.
 Type II stress: Safety factors given in AD Merkblatt BO are 75% utilized. Safety factor correction $S_r \geq 4S/3$.
 Type III stress: Safety factors given in AD Merkblatt BO are 25% utilized. Safety factor correction $S_r \geq 4S$.
 (For details see AD Merkblatt W10, section 3 'Beanspruchungsfall'.)

Table 20. Effects of exposure at sub-zero temperatures on the room-temperature tensile properties of annealed Types 304, 321 and 347 stainless steels.

AISI type	Temperature °C	Time h	Condition	0.2% proof stress			Tensile strength			Elongation on 51 mm %
				N/mm ²	tonf/in ²	kgf/mm ²	N/mm ²	tonf/in ²	kgf/mm ²	
304	-269	22	before	270	17.5	27.5	600	39	61	63
			after	260	17	26.5	605	39	61.5	66
321	-269	22	before	180	11.5	18	525	34	53.5	65
			after	170	11	17	560	36	57	58
347	-76	100	before	270	17.5	27.5	655	42.5	67	49
			after	280	18	28.5	680	44	69	49
347	-269	22	before	290	19	29.5	605	39	61.5	53
			after	290	19	29.5	615	40	62.5	54

Figure 1 Tensile properties of annealed stainless steels.

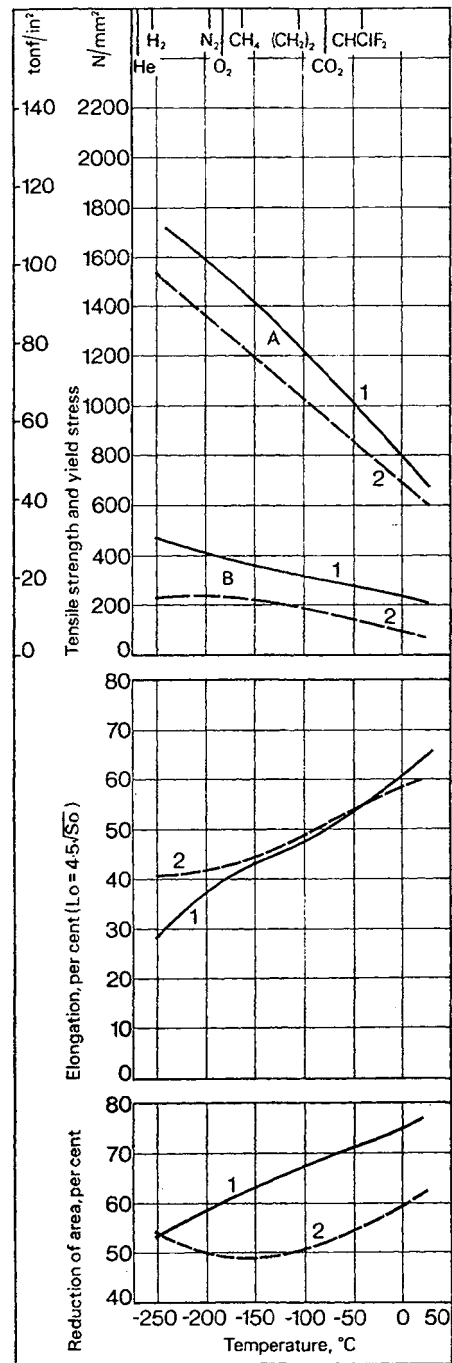

A tensile strength
B yield stress
1. Type 304
2. Type 304L

Figure 2 Tensile properties of cold-worked stainless steels.

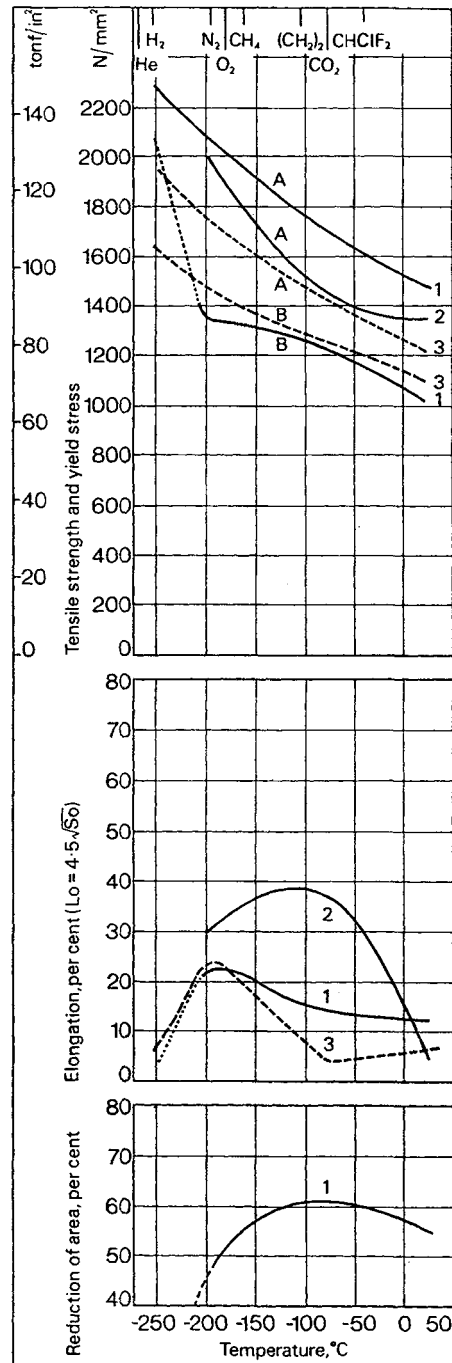

A tensile strength
B yield stress
1. Type 304—cold drawn to 1450 N/mm² (94 tonf/in²) (148 kgf/mm²)
2. Type 304—cold rolled 60 per cent
3. Type 304L—full hard

Figure 3 Tensile properties of annealed Type 316 stainless steel.

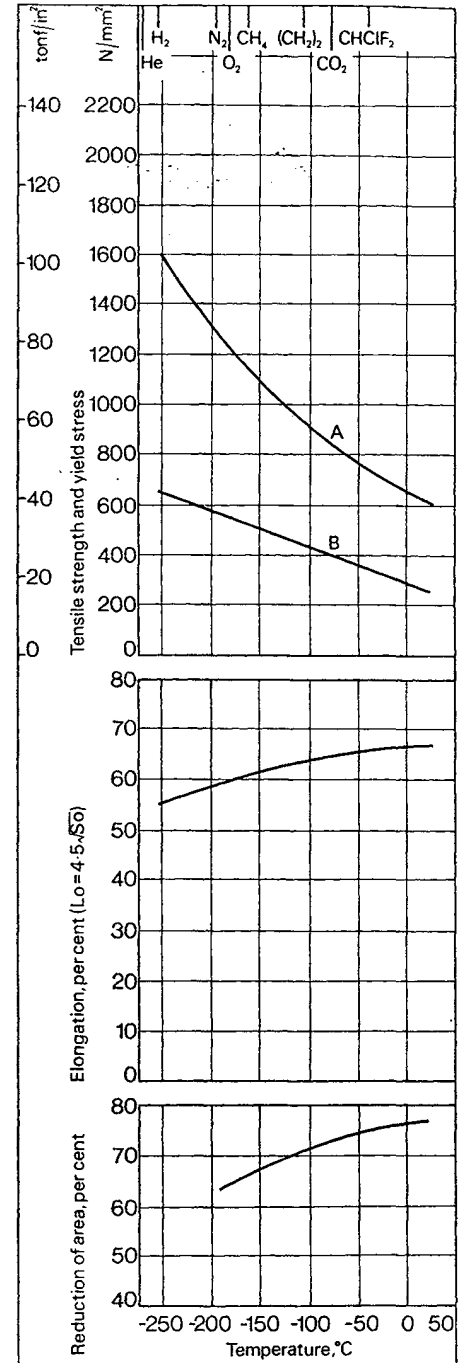

A tensile strength
B yield stress

Figure 4 Tensile properties of Type 316 stainless steel cold drawn 25 per cent.

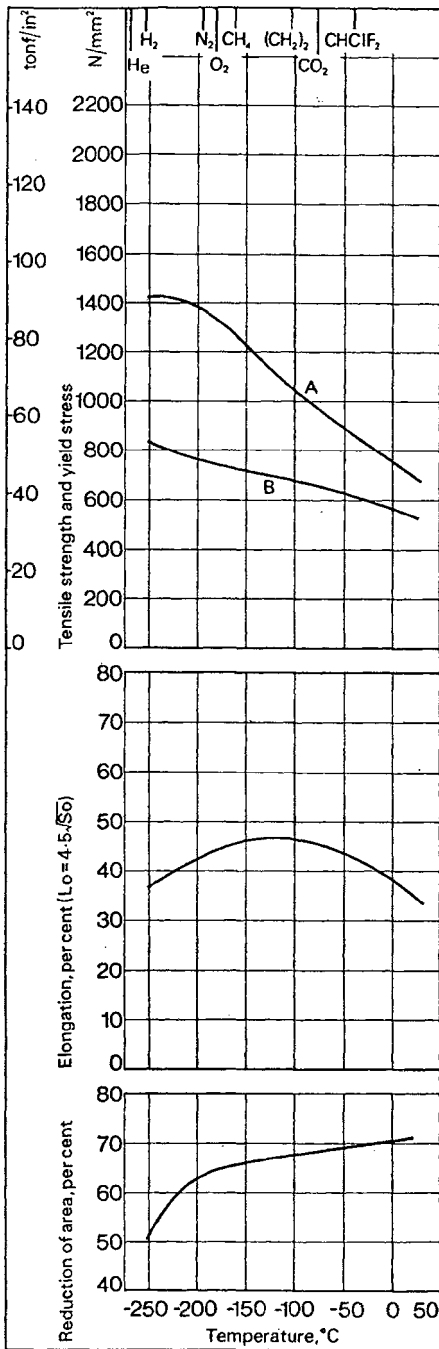

A tensile strength B yield stress

Figure 6 Tensile properties of annealed Type 347 stainless steel.

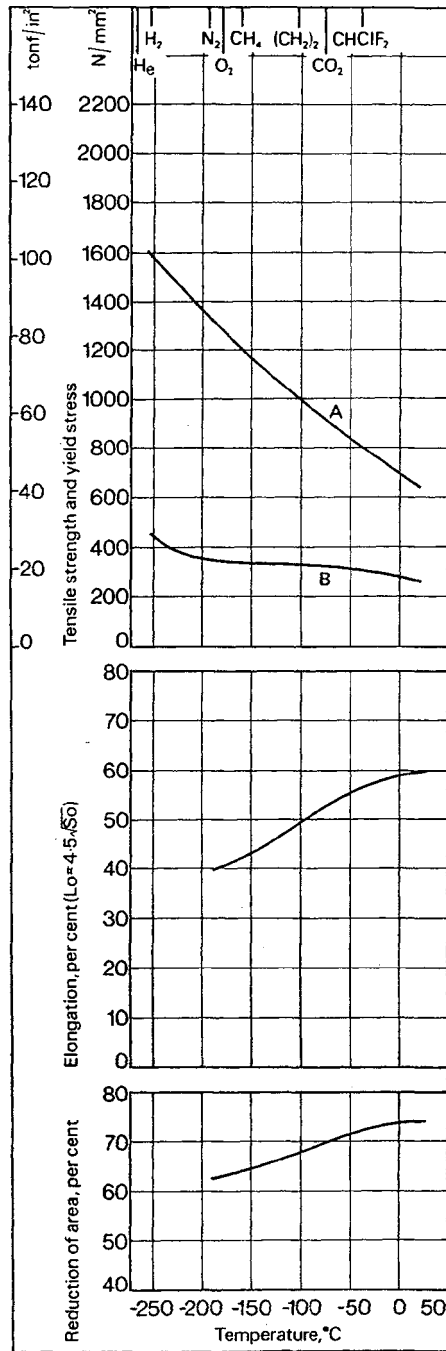

A tensile strength B yield stress

Figure 6 Tensile properties of Type 347 stainless steel cold drawn 10 per cent.

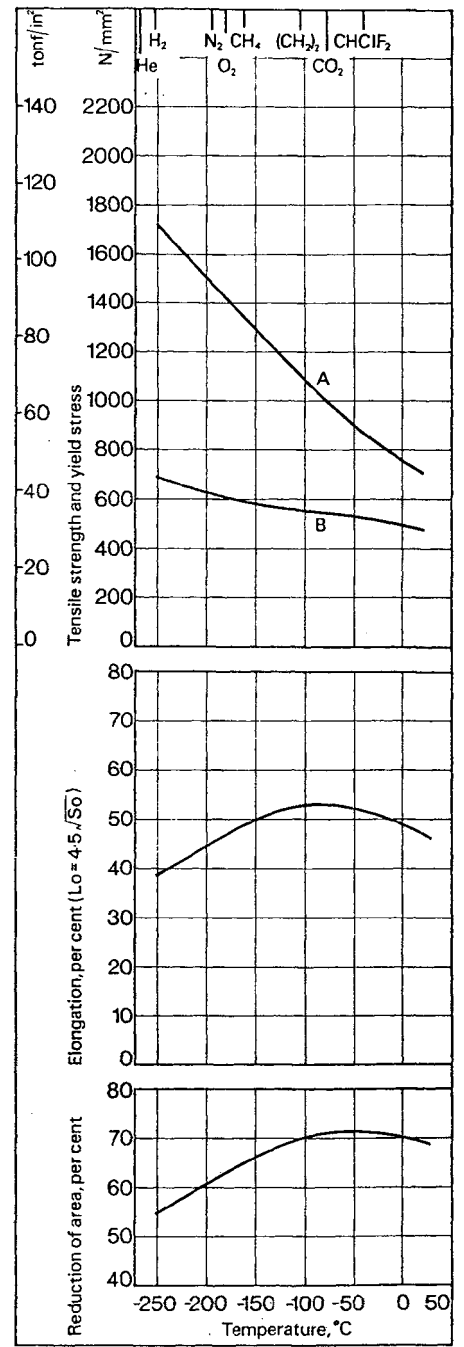

A tensile strength B yield stress

Figure 7 Tensile properties of annealed Type 321 stainless steel.

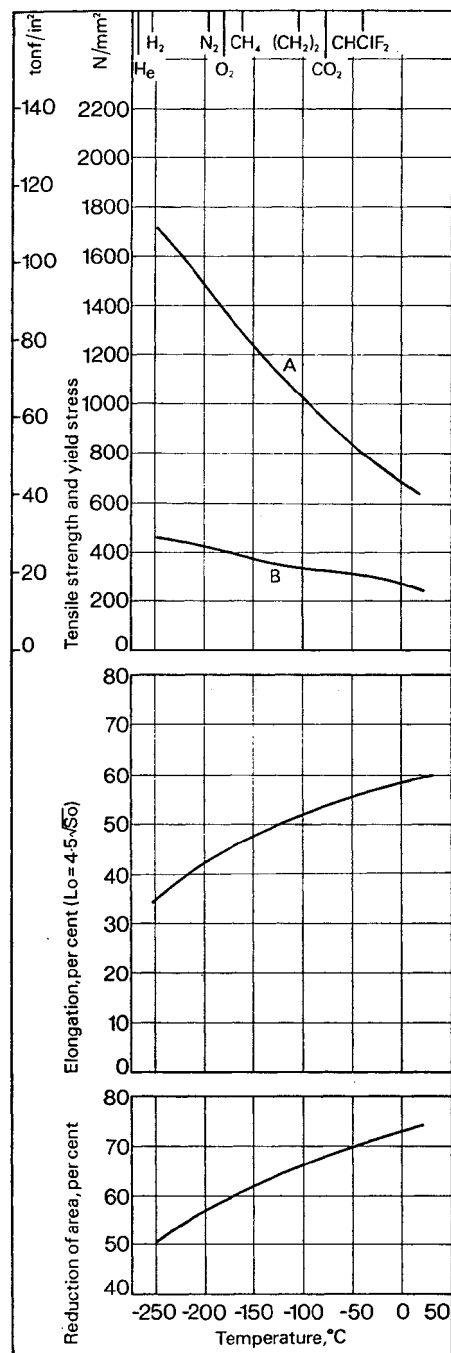

A tensile strength B yield stress

Figure 8 Tensile strength of cold-worked Type 321 stainless steel.

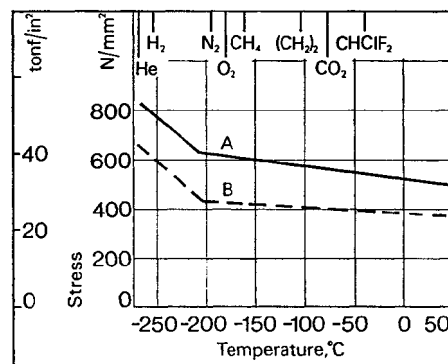
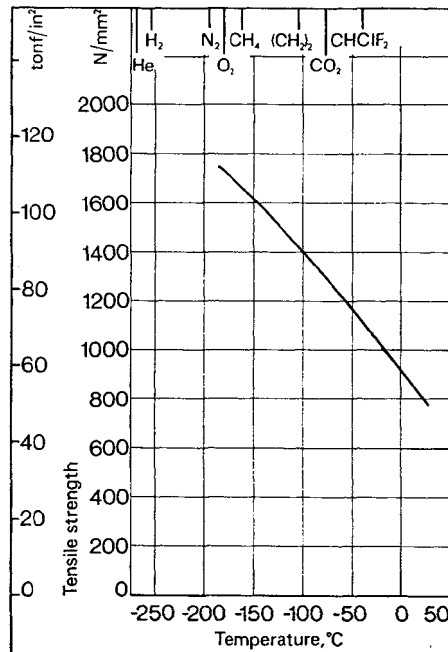
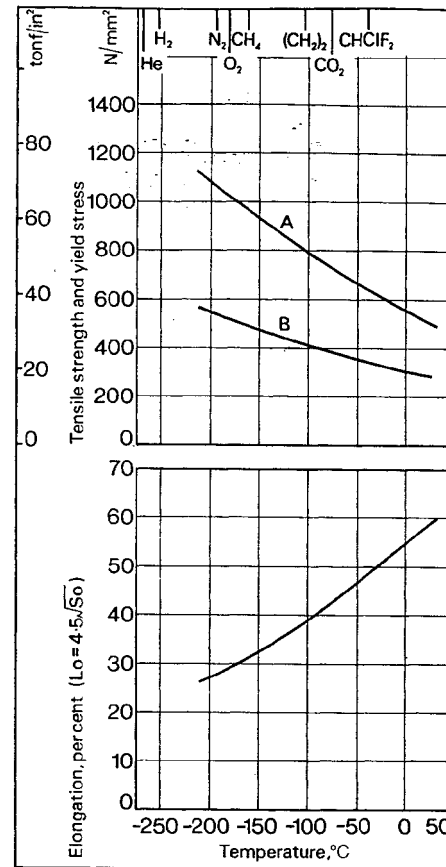

Figure 10 Compressive properties of Type 304 stainless steel.

A yield stress B elastic limit

Figure 9 Tensile properties of Type CF-8 cast stainless steel (similar to Type 304 wrought).



A tensile strength B yield stress

Table 21. Effect of temperature on Young's modulus of elasticity of cold-worked stainless steels.

AISI steel type	Tensile strength at room temperature			Modulus of elasticity in tension					
				room temperature			-196°C		
	N/mm ²	tonf/in ²	kgf/mm ²	kN/mm ²	10 ⁶ lbf/in ²	10 ³ kgf/mm ²	kN/mm ²	10 ⁶ lbf/in ²	10 ³ kgf/mm ²
304	1320	85	135	168	24.4	17.1	181	26.3	18.5
347	1070	69	109	172	24.9	17.5	186	27.0	19.0
347	1170	76	119	160	23.2	16.3	190	27.6	19.4

Figure 11 Representative Charly V-notch impact values of annealed Type 304 stainless steel.

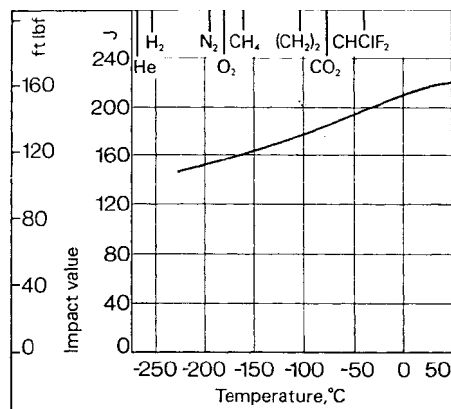

Figure 12 Representative Charly V-notch impact values of Type 304L stainless steel.

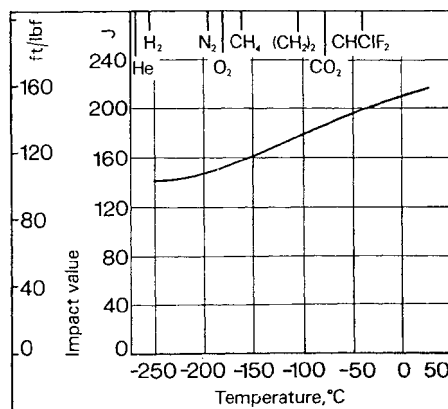

Figure 13 Representative Charly V-notch impact values of annealed Type 316 stainless steel.

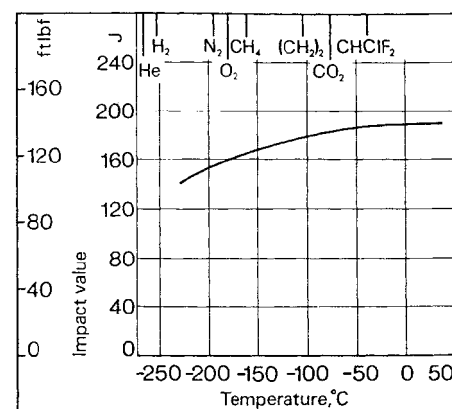

Table 22. Effect of prolonged exposure at -196°C on the room-temperature impact properties of Type 304 stainless steel.

Exposure time	Charpy U-notch impact value			
	J	ft lbf	daJ/cm ²	kgfm/cm ²
none	108–132	80–97	21.5–26.5	22–27
30 minutes	122–123	90–91	24.5	25
6 months	113–123	83–91	22.5–24.5	23–25
12 months	111–121	82–89	22–24	22.5–24.5

Table 23. Electrodes for welding stainless steels.

Parent steel type		Electrode-type	Coating*	Current
Wrought	Cast			
304	CF-8	E308	lime titania	dc ac-dc
304L	CF-3	308L	lime-titania	dc
		E347	lime titania	dc ac-dc
316	CF-8M	E316	lime titania	dc ac-dc
316L	CF-3M	316L	lime-titania	dc
		316Nb	lime titania	dc ac-dc
321	—	E347	lime titania	dc ac-dc
347	CF-8C	E347	lime titania	dc ac-dc

* Lime coatings are generally preferred for cryogenic service since it is felt in some quarters that they give weld deposits having superior low-temperature impact strength. However, good low-temperature impact strength has been obtained using coatings containing titania – see table 29. Electrode manufacturers should be consulted.

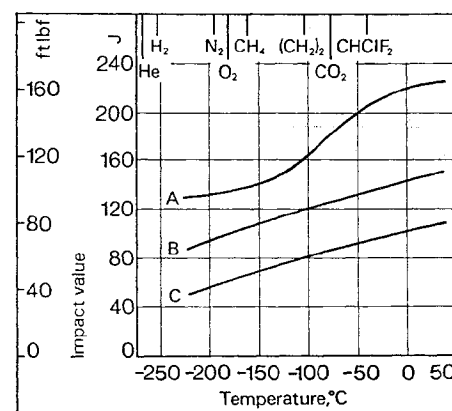

Figure 14 Representative Charpy V-notch impact values of Type 321 stainless steel.

A annealed B 1/4 hard C 1/2 hard

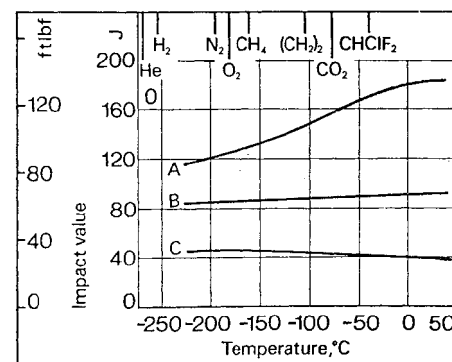
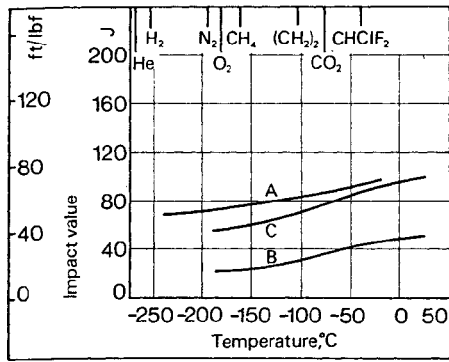

Figure 15 Representative Charpy V-notch impact values of Type 347 stainless steel.

A annealed B 1/4 hard C 1/2 hard

Figure 16 Charpy U-notch impact values of cast stainless steels.



A Type CF-8 B Type CF-8C C Type CF-8M

Figure 17 Representative Charpy V-notch impact values of cast stainless steels.

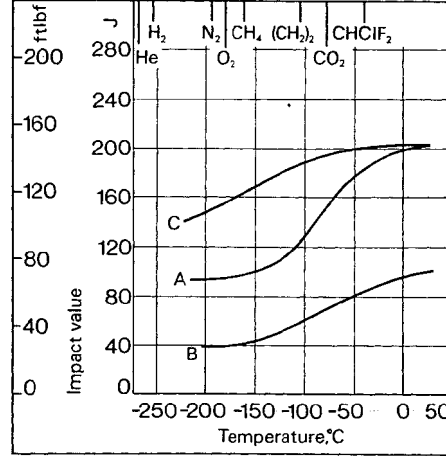

A Type CF-8 B Type CF-8C C Type CF-8M

Figure 18 Effect of sensitization (2h/650°C) on Charpy U-notch impact values of stainless steels.

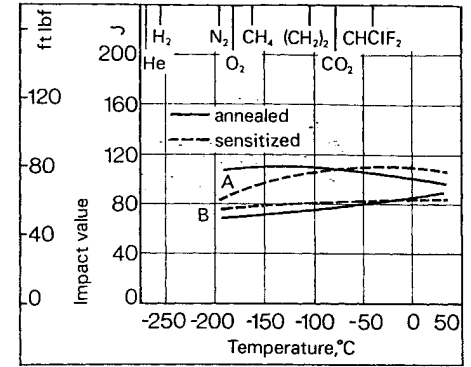

A Type 304 B Type 304L

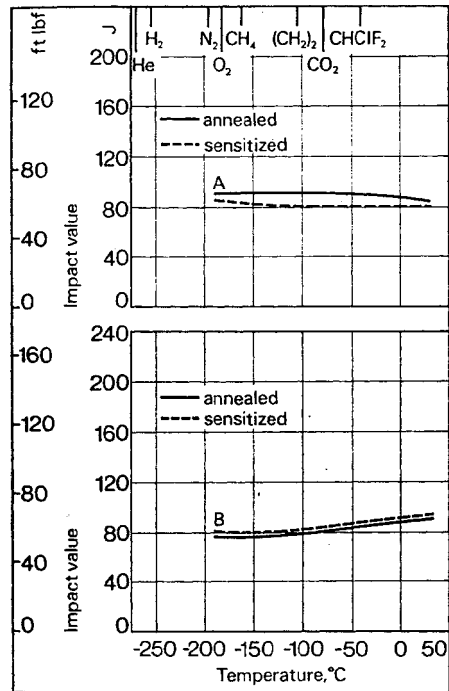

Figure 19 Effect of sensitization (2h/650°C) on Charpy U-notch impact values of stainless steels.

A Type 347 B Type 316

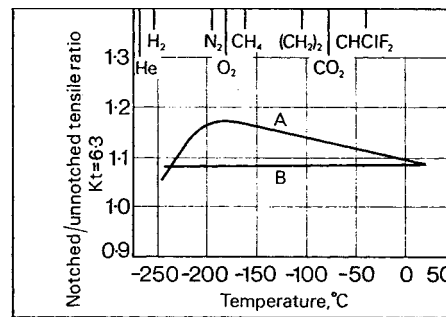

Figure 20 Notched/unnotched tensile strength ratio for fully hard Type 304L stainless steel.

A transverse B longitudinal

Table 24. Temperature ranges for post-weld heat treatment.

AISI steel type	Stress-relief temperature °C
304, 304L, 321, 347	1010-1100
316, 316L	1010-1065

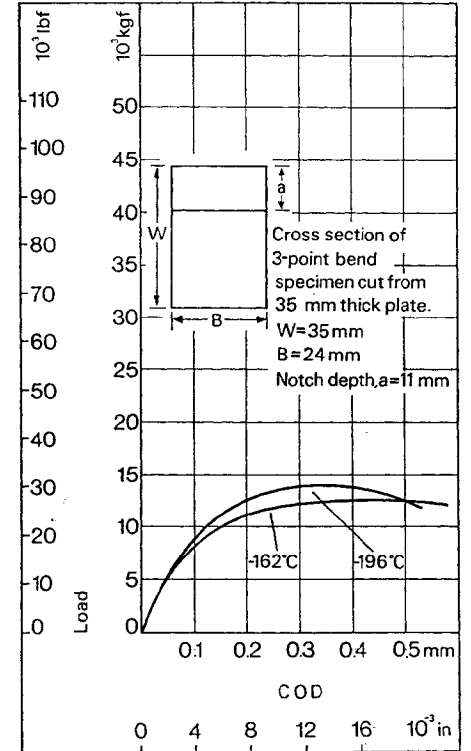

Figure 21 Load-crack opening displacement diagram for Type 304N (nitrogen strengthened) stainless steel.

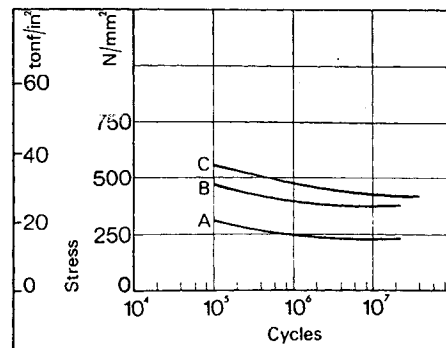

Figure 22 Representative rotating bending fatigue curves at room temperature for Type 304 stainless steel.

A annealed B cold worked 44 per cent C cold worked 82 per cent

Figure 23 Reciprocating beam fatigue curves for Type 304 stainless steel cold worked to a tensile strength of 1450 N/mm² (94 tonf/in²) (148 kgf/mm²).

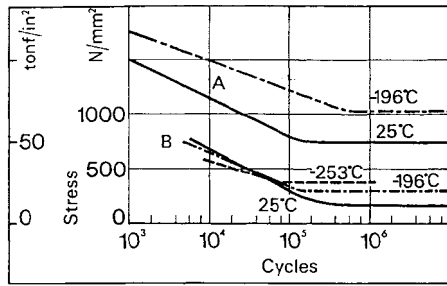
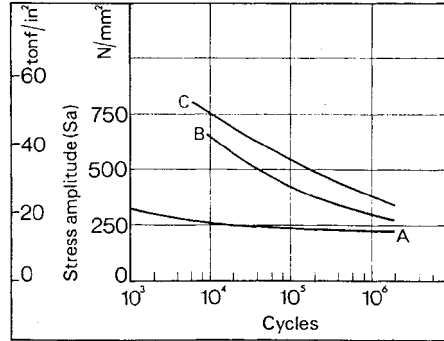
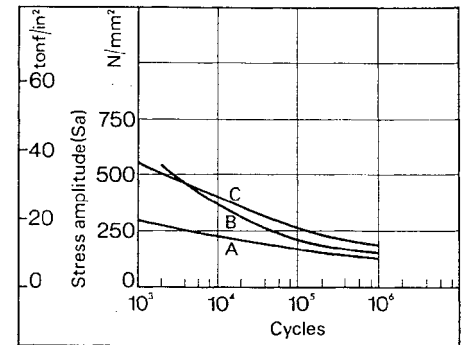

Figure 24 Representative axial load fatigue curves for annealed Type 321 sheet, 2.3mm (0.09 in) thick.



A at 20°C B at -196°C C at -253°C

Figure 25 Representative axial load notch fatigue curves (Kt = 3.5) for annealed Type 321 sheet, 2.3 mm (0.09 in) thick.



A at 20°C B at -196°C C at -253°C

Table 25. Low-temperature tensile properties of manual metal-arc weld joints in 13 mm thick plate of Types 304 (316 Ti) and 347 stainless steels.

Plate material type	Electrode type	Heat treatment	Test temperature °C	0.2% proof stress		Tensile strength		Elongation on 13mm (test-piece 6.4 mm diameter) %
				N/mm ²	tonf/in ² (kgf/mm ²)	N/mm ²	tonf/in ² (kgf/mm ²)	
304	304	As welded	20	260	17 (26.5)	640	41.5 (65)	50
			-78	260	17 (26.5)	960	62 (98)	22
			-196	270	17.5 (27.5)	1610	104 (164)	24
(316Ti)	(316Nb)	As welded	20	380	24.5 (38.5)	610	39.5 (62)	-
			-78	450	29 (46)	950	61.5 (97)	25
			-196	590	38 (60)	1040	67.5 (106)	15
347	347	As welded	20	270	17.5 (27.5)	610	39.5 (62)	-
			-78	280	18 (28.5)	930	60 (95)	30
			-196	270	17.5 (27.5)	1310	85 (134)	14

Figure 26 Fatigue curves for annealed Type 347 stainless steel.

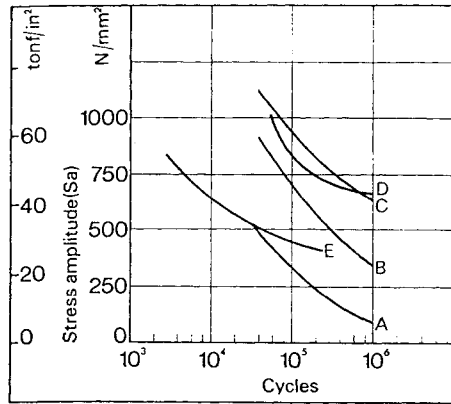

$$(R = \frac{\text{mean stress} - S_a}{\text{mean stress} + S_a} = -1.0)$$

A reversed bending, sheet specimens, steel 1 at 20°C
 B reversed bending, sheet specimens, steel 1 at -78°C
 C reversed bending, sheet specimens, steel 1 at -196°C
 D reversed bending, sheet specimens, steel 1 at -253°C
 E axial loading, bar specimens, steel 2 at 20°C

Figure 27 Reversed bending notch fatigue curves (Kt=3.2) for annealed Type 347 sheet.

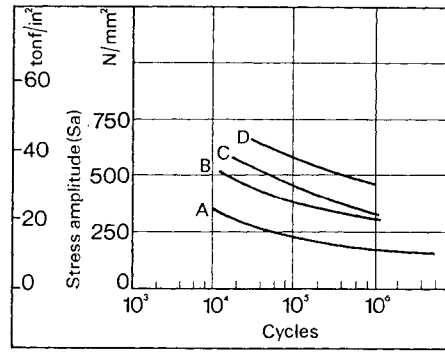

$$(R = \frac{\text{mean stress} - S_a}{\text{mean stress} + S_a} = -1.0)$$

A steel 1 at 20°C
 B steel 1 at -78°C
 C steel 1 at -196°C
 D steel 1 at -253°C

Figure 28 Reversed bending notch fatigue curves (Kt=6.4) for annealed Type 347 sheet.

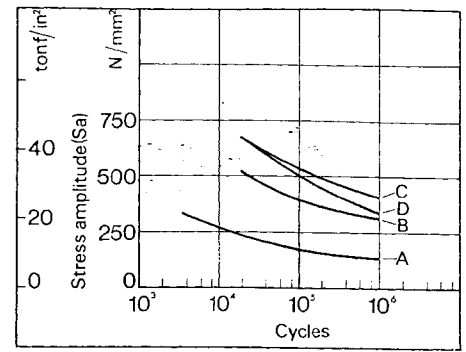

$$(R = \frac{\text{mean stress} - S_a}{\text{mean stress} + S_a} = -1.0)$$

A steel 1 at 20°C
 B steel 1 at -78°C
 C steel 1 at -196°C
 D steel 1 at -253°C

Table 26. Tensile properties of weld joints in high proof stress stainless steels.

Plate material type	Plate thickness		Welding process	Electrode or filler wire	Test temperature °C	1.0% proof stress			Tensile strength			Elongation Lo=5.65 √So %
	mm	in				N/mm²	tonf/in²	kgf/mm²	N/mm²	tonf/in²	kgf/mm²	
(304N) or (304LN)	6-32	¼-1¼	manual metal arc	BS2926 Grade B (Type 347)	20	360-440	23-28	37-45	590-730	38-47	60-74	18-40
					-100	560-770	36-50	57-79	-	-	-	-
					-196	830-910	54-59	85-93	-	-	-	-
	6-32	¼-1¼	metal inert gas	BS2901 Grade A8Nb (Type 347)	20	380-450	25-29	39-46	610-690	39-45	62-70	13-39
					-100	660-710	43-46	67-72	-	-	-	-
					-196	850-900	55-58	87-92	-	-	-	-
19-32	¾-1¼	submerged arc	BS2901 Grade A8Nb (Type 347)	20	370-420	24-27	38-43	620-700	40-45	63-71	10-42	
				-100	690-760	45-49	70-77	-	-	-	-	
(316N) or (316LN)	6-32	¼-1¼	manual metal arc	BS2926 Grade C (Type 316)	20	380-460	25-30	39-47	670-740	43-48	68-75	36-40
					-100	680-800	44-52	69-82	-	-	-	-
	6-32	¼-1¼	metal inert gas	BS2901 Grade A12 (Type 316)	20	380-480	25-31	39-49	660-720	43-47	67-73	12-21
					-100	660-730	43-47	67-74	-	-	-	-
	19-32	¾-1¼	submerged arc	BS2901 Grade A12 (Type 316)	20	350-380	23-25	36-39	650-690	42-45	66-70	12-26
					-100	690-740	45-48	70-75	-	-	-	-
(347N)	6-19	¼-¾	manual metal arc	BS2926 Grade B (Type 347)	20	510-550	33-36	52-56	750-760	49	76-77	21-25
					-100	740-850	48-55	75-87	-	-	-	-
					-196	910	59	93	-	-	-	-
	19-32	¾-1¼	metal inert gas	BS2901 Grade A8Nb (Type 347)	20	450-490	29-32	46-50	660-690	43-45	67-70	15-21
					-100	510-680	33-44	52-69	-	-	-	-
					-196	790-850	51-55	81-87	-	-	-	-

Table 27. Impact properties of welded joints.

AISI steel type	Condition	Charpy specimen	Location of notch	Charpy impact value					
				30°C		-196°C		-262°C	
				J	ft lbf (kgfm/cm ²)	J	ft lbf (kgfm/cm ²)	J	ft lbf (kgfm/cm ²)
304	as welded	U-notch	in weld	45	33 (9.2)	28	21 (5.7)	–	–
	as welded	V-notch	in weld	80	59 (10.2)	27	20 (3.4)	–	–
	annealed	V-notch	in weld	83	61 (10.6)	42	31 (5.4)	–	–
304L	as welded	U-notch	in weld	43	32 (8.8)	22	16 (4.5)	26	19 (5.3)
	as welded	U-notch	heat-affected zone	95	70 (19.4)	88	65 (17.9)	81	60 (16.5)
	as welded	U-notch	base metal	103	76 (21)	96	71 (19.6)	95	70 (19.4)
	as welded	V-notch	in weld	–	–	–	–	34	25 (4.3)
	as welded	V-notch	heat-affected zone	–	–	–	–	94	69 (12)
	as welded	V-notch	base metal	–	–	–	–	148	109 (18.9)
316	as welded	U-notch	in weld	58	43 (11.8)	30	22 (6.1)	–	–
316L	as welded	U-notch	in weld	42	31 (8.6)	31	23 (6.3)	–	–
	as welded	U-notch	heat-affected zone	61	45 (12.4)	50	37 (10.1)	–	–
	as welded	U-notch	base metal	73	54 (14.9)	69	51 (14.1)	–	–
347	as welded	U-notch	in weld	38	28 (7.7)	22	16 (4.5)	–	–
	annealed	U-notch	in weld	41	30 (8.4)	28	21 (5.7)	–	–

Table 28. Low temperature impact properties of metal-inert-gas welds in 89 mm (32 in) plate of Types 304 and 304L stainless steels. (Average of several tests.)

AISI steel type	Location of notch	Charpy V-notch impact value					
		-196°C			-253°C		
		J	ft lbf	kgf m/cm ²	J	ft lbf	kgf m-/cm ²
304	weld metal	53	39	6.8	31	23	4
	heat-affected zone: 1.5 mm ($\frac{1}{16}$ in) from weld interface	71	52	9	72	53	9.2
	3 mm ($\frac{1}{8}$ in) from weld interface	85	63	10.8	84	62	10.7
	13 mm ($\frac{1}{2}$ in) from weld interface	88	65	11.2	81	60	10.3
	base metal	122	90	15.6	118	87	15
304L	weld metal	66	49	6.2	61	45	7.8
	heat-affected zone: 1.5 mm ($\frac{1}{16}$ in) from weld interface	80	59	10.2	72	53	9.2
	3 mm ($\frac{1}{8}$ in) from weld interface	76	56	9.7	61	45	7.8
	13 mm ($\frac{1}{2}$ in) from weld interface	89	66	11.3	87	64	11
	base metal	94	69	12	92	68	11.7

Table 29. Impact properties of manual metal-arc weld-metal deposits.

Type of plate	Electrode type	Heat treatment	Ferrite content per cent	Charpy U-notch impact value					
				20°C		-76°C		-196°C	
				J	ft lbf (kgf m/cm ²)	J	ft lbf (kgf m/cm ²)	J	ft lbf (kgf m/cm ²)
304	304	as deposited	–	43–50	32–37 (8.8–10.2)	33–38	24–28 (6.7–7.7)	24–31	18–23 (4.9–6.3)
		annealed ½h 1060°C, WQ		56–66	41–49 (11.4–13.5)	53–57	39–42 (10.8–11.6)	43–57	32–42 (8.8–11.6)
304	308	as deposited	–	42–45	31–33 (8.6–9.2)	28–34	21–25 (5.7–6.9)	19–27	14–20 (3.9–5.5)
		annealed ½h 1060°C, WQ		49–52	36–38 (10–10.6)	41	30 (8.4)	41–42	30–31 (8.4–8.6)
316	316	as deposited	0.5	37–47	27–35 (7.5–9.6)	34–38	25–28 (6.9–7.7)	19–28	14–21 (3.9–5.7)
		stress relieved 2h 650°C		41–46	30–34 (8.4–9.4)	34–37 –	25–27 (6.9–7.5)	18–19	13–14 (3.7–3.9)
		stabilized 2h 840°C		35–41	26–30 (7.1–8.4)	28–30	21–22 (5.7–6.1)	15–20	11–15 (3.1–4.1)
		annealed ½h 1060°C, WQ		43–49	32–36 (8.8–10)	38–41	28–30 (7.7–8.4)	30	22 (6.1)
316	316	as deposited	8.0	42–43	31–32 (8.6–8.8)	38–39	28–29 (7.7–8)	24–27	18–20 (4.9–5.5)
		stress relieved 2h 650°C		34–37	25–27 (6.9–7.5)	23–24	17–18 (4.7–4.9)	9–11	7–8 (1.8–2.2)
		stabilized 2h 840°C		15–16	11–12 (3.1–3.3)	9–11	7–8 (1.8–2.2)	4	3 (0.8)
		annealed ½h 1060°C, WQ		43–56	32–41 (8.8–11.4)	38–45	28–33 (7.7–9.2)	33–38	24–28 (6.7–7.7)
321	347	as deposited	–	43	32 (8.8)	33–37	24–27 (6.7–7.5)	24–35	18–26 (4.9–7.1)
		annealed ½h 1060°C, WQ		39–43	29–32 (8–8.8)	38–49	28–36 (7.7–10)	31–37	23–27 (6.3–7.5)
347	347	as deposited	none	35–39	26–29 (7.1–8)	26–37	19–27 (5.3–7.5)	24–27	18–20 (4.9–5.5)
		stress relieved 2h 650°C		34–37	25–27 (6.9–7.5)	27	20 (5.5)	18–19	13–14 (3.7–3.9)
		stabilized 2h 840°C		30	22 (6.1)	19–23	14–17 (3.9–4.7)	19–22	14–16 (3.9–4.5)
		annealed ½h 1060°C, WQ		33–35	24–26 (6.7–7.1)	34–35	25–26 (6.9–7.1)	22–27	16–20 (4.5–5.5)
347	347	as deposited	3.5	37–45	27–33 (7.5–9.2)	28–39	21–29 (5.7–8)	22–30	16–22 (5.5–6.1)
		stress relieved 2h 650°C		33–37	24.27 (6.7–7.5)	20–22	15–16 (4.1–4.5)	12–18	9–13 (2.4–3.7)
		stabilized 2h 840°C		26–30	19–22 (5.3–6.1)	20–24	15–18 (4.1–4.9)	9–27	7–20 (1.3–5.5)
		annealed ½h 1060°C, WO		34–37	25–27 (6.9–7.5)	27–41	20–30 (5.5–8.4)	31–35	23–26 (6.3–7.1)
347	347*	as deposited	–	34–38	25–28 (6.9–7.7)	24–31	18–23 (4.9–6.3)	18–37	13–27 (3.7–7.5)
		annealed ½h 1060°C, WQ		38–42	28–31 (7.7–8.6)	27–37	20–27 (5.5–7.5)	28–31	21–23 (5.7–6.3)

* Titania coated: all other electrodes lime coated.

Table 30. Low-temperature impact properties of weld-joints in high proof stress stainless steels (test-piece notch located in heat-affected zone).

Steel type	Welding process	Electrode or filler wire	Plate thickness		Impact value* at -196°C					
					Charpy V-notch			DVM		
			mm	in	J	ft lbf	kgf m/cm ²	J	ft lbf	kgf m/cm ²
(304N) or (304LN)	manual metal arc	BS2926 Grade B (Type 347)	13	½	38–91	28–67	4.8–11.6	–	–	–
			19	¾	37–130	27–96	4.7–16.6	50–61	37–45	7.3–8.9
			32	1¼	50–69	37–51	6.4–8.8	50–123	37–91	7.3–17.9
	submerged arc	BS2901 Grade A8Nb (Type 347)	19	¾	69 (single test)	51	8.8	–	–	–
(316N) or (316LN)	manual metal arc	BS2926 Grade C (Type 316)	13	½	75 (single test)	55	9.6	–	–	–
			19	¾	35–117	26–86	4.5–14.9	47–66	35–49	6.8–9.6
			32	1¼	–	–	–	57–65	42–48	8.3–9.5
	submerged arc	BS2901 Grade A12 (Type 316)	19	¾	42–50	31–37	5.4–6.4	–	–	–
			32	1¼	37 (single test)	27	4.7	–	–	–

* Range of values from several tests unless stated otherwise.

Table 31. Physical properties of wrought austenitic stainless steels (Types 304, 304L, 316, 316L, 321 and 347). (At room temperature except as stated otherwise).

Specific gravity	–	7.90–7.96			
Mean coefficient of thermal expansion. 20–100°C	10 ⁻⁶ /K	16–17			
Specific heat	J/kg K	480–500			
	cal/g °C	0.115–0.12			
Thermal conductivity	W/m K	13.4–15.19			
	cal/cm s °C	0.032–0.038			
Electrical resistivity	μ Ω cm	70–80			
Modulus of elasticity	kN/mm ²	190–200			
	10 ⁶ lbf/in ²	28–29			
Shear modulus	kN/mm ²	74.5–78			
	10 ⁶ lbf/in ²	10.8–11.3			
Poissons ratio	–	0.245–0.280			
Magnetic permeability of annealed steel:	μ max at 20°C	μ max at -196°C	μ max at -253°C	μ max at -269°C	μ (8 × 10 ⁴ oersteds) at -269°C
Type 304	1.005–1.03	2.02–2.03	2.0–2.01	–	–
Type 304L	1.08–1.3	1.2–1.6	–	1.1–1.5	1.009
Type 316	1.02–1.05	–	–	–	–
Type 316L	1.02–1.1	1.03–1.09	–	1.03–1.09	1.009
Type 321	1.03–2.0	–	–	2.75	1.017
Type 347	1.005–1.03	–	–	1.40	1.008
Type (316LN)	1.0	1.0–1.01	–	1.03–1.06	–

Figure 29 Specific gravity of Types 316 and 347 stainless steels.

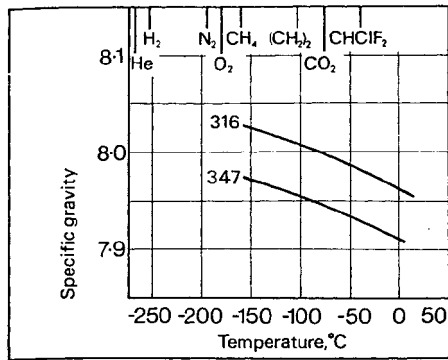
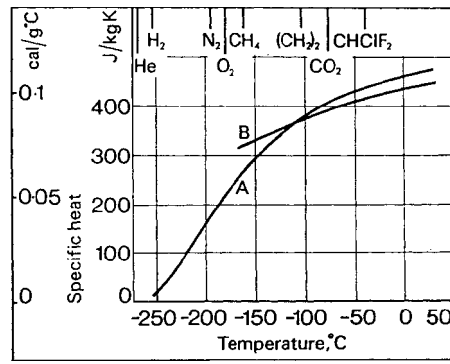

Figure 30 Specific heat of stainless steels.



A Type 304 B Types 316 and 347

Figure 31 Mean linear thermal expansion of Type 304 stainless steel.

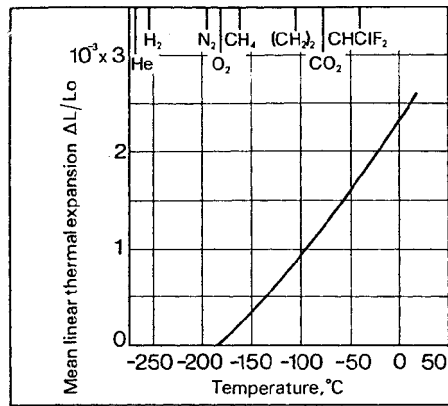
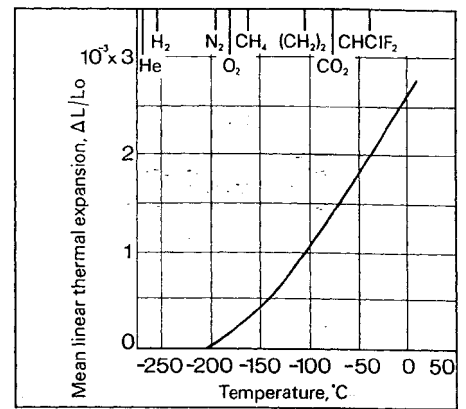

Figure 32 Mean linear thermal expansion of Type 316 stainless steel.

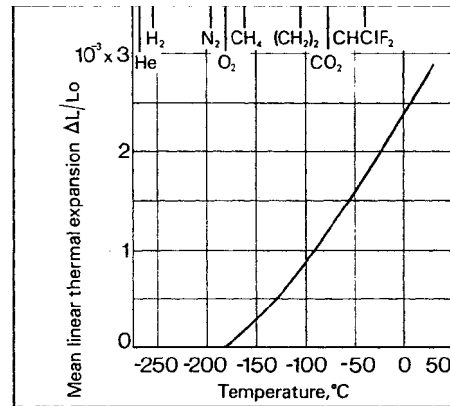

Figure 33 Mean linear thermal expansion of Type 347 stainless steel.

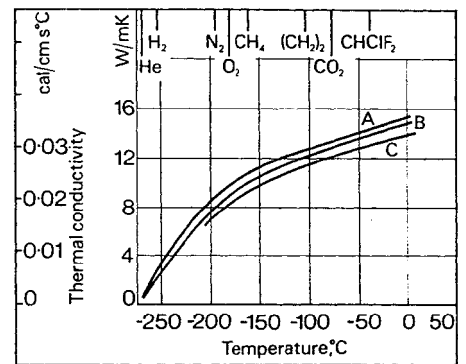

Figure 34 Thermal conductivity of stainless steels.

A Type 304 B Type 347 C Type 316

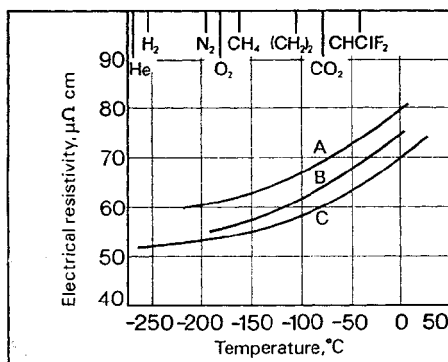

Figure 35 Electrical resistivities of stainless steels.

A Type 316 B Type 321 C Type 347

Table 32. Physical properties of cast stainless steels at 20°C.

ASTM type	Specific gravity	Specific heat		Thermal conductivity		Mean thermal expansion coefficient 20–100°C 10 ⁻⁶ /K	Electrical resistivity μ Ω cm	Magnetic permeability
		J/kg K	cal/g °C	W/m K	cal/cm s °C			
CF-3	7.75	500	0.12	15.9	0.038	16.2	76.2	1.0–1.3
CF-3M	7.75	500	0.12	16.3	0.039	16.0	82.0	1.5–2.5
CF-8	7.75	500	0.12	15.9	0.038	16.2	76.2	1.0–1.3
CF-8C	7.75	500	0.12	16.0	0.038	16.8	71.0	1.2–1.8
CF-8M	7.75	500	0.12	16.3	0.039	16.0	82.0	1.5–2.5

Table 33. Mean coefficients of thermal expansion of Types 304, 316 and 347.

AISI steel type	Mean coefficient of thermal expansion, 10 ⁻⁶ /K					
	0 to 20°C	-30 to 20°C	-50 to 20°C	-100 to 20°C	-150 to 20°C	-200 to 20°C
304 (A)	16.0	–	15.2	14.4	13.7	13.2
304 (B)	15.6	–	14.8	14.4	13.9	13.7
316 (A)	14.7	14.4	–	13.8	13.2	12.6
316 (C)	–	15.2	–	15.0	14.8	–
347 (A)	15.9	15.5	–	15.0	14.3	13.0
347 (C)	–	16.0	–	15.4	14.7	–

(A) Investigation A

(B) Investigation B

(C) Investigation C

Location of data

		U.S.A.		British		German		French		Italian		Swedish				
Specifications:																
Wrought steels	table	1(a)–1(d)		2(a)–2(d)		3(a)–3(e)		4(a)–4(b)		5(a)–5(b)		6(a)–6(b)				
Cast steels	table	7	10	7	8	7	11	—		(proprietary guaranteed)		7	9			
High proof stress steels	table	—		12	13	12	15	12	14	12	16	12	17			
Design codes	table	18		18		19		—		—		—				
		Type 304		Type 304L		Type 316		Type 316L		Type 321		Type 347		Types (304N, 304LN)	Types (316 N, 316LN)	Type (347N)
Mechanical Properties:																
Tensile (annealed)	figure	1		1		3		—		7		5		—	—	—
Tensile (cold-worked)	figure	2		2		4		—		8		6		—	—	—
Tensile (cast)	figure	9		—		—		—		—		—		—	—	—
Notched tensile	figure	—		20		—		—		—		—		—	—	—
Tensile (effects of exposure at low temperatures)	table	20		—		—		—		20		20		—	—	—
Tensile (weld-joints)	table	25		—		25		—		—		25		26	26	26
Compressive	figure	10		—		—		—		—		—		—	—	—
Impact (wrought)	figure	11		12		13		—		14		15		—	—	—
Impact (effects of exposure at low temperatures)	table	22		—		—		—		—		—		—	—	—
Impact (cast)	figure	16	17	—		16	17	—		—		16	17	—	—	—
Impact (effects of sensitization heat treatment)	figure	18		18		18		—		—		18		—	—	—
Impact (weld-joints)	table	27	28	29	27	28	27	29	27	29	27	29	27	29	30	30
Fracture toughness (COD)	figure	—		—		—		—		—		—		21	—	—
Fatigue	figure	22	23	—		—		—		24	25	26	27	28	—	—
		Type 304		Type 304L		Type 316		Type 316L		Type 321		Type 347		Types (304N, 304LN)	Types (316N, 316LN)	Type (347N)
		W	C	W	C	W	C	W	C	Wrought	W	C	Wrought	Wrought	Wrought	
Physical properties:																
Specific gravity	table	31	32	31	32	31	32	31	32	31	31	32	—	—	—	—
	figure	—	—	—	—	29	—	—	—	—	29	—	—	—	—	—
Specific heat	table	31	32	31	32	31	32	31	32	31	31	32	—	—	—	—
	figure	30	—	—	—	30	—	—	—	—	30	—	—	—	—	—
Thermal conductivity	table	31	32	31	32	31	32	31	32	31	31	32	—	—	—	—
	figure	34	—	—	—	34	—	—	—	—	34	—	—	—	—	—
Thermal expansion	table	31	32	31	32	31	32	31	32	31	31	32	—	—	—	—
	figure	33	—	—	—	33	—	—	—	—	33	—	—	—	—	—
Electrical resistivity	table	31	32	31	32	31	32	31	32	31	31	32	—	—	—	—
	figure	—	—	—	—	35	—	—	—	35	35	—	—	—	—	—
Magnetic permeability	table	31	32	31	32	31	32	31	32	31	31	32	—	—	31 (316LN)	—
Modulus of elasticity	table	21	—	31	—	31	—	31	—	31	21	—	—	—	—	—
	figure	31	—	—	—	—	—	—	—	—	31	—	—	—	—	—
Shear modulus	table	31	—	31	—	31	—	31	—	31	31	—	—	—	—	—
		Type 304		Type 304L		Type 316		Type 316L		Type 321		Type 347				
Additional data:																
Welding electrodes	table	23		23		23		23		23		23				
Post-weld stress relief temperatures	table	24		24		24		24		24		24				

W = Wrought C = Cast